

AKI
AWAIS KAHLOO INDUSTRY

AWAIS KAHLOO INDUSTRY
MANUFACTURERS & EXPORTERS DENTAL INSTRUMENTS



CATALOGUE
DENTAL
INSTRUMENTS



WELCOME TO AWAIS KAHLOO INDUSTRY.

Awais Kahloo Industry is a renowned surgical instruments manufacturer and exporter based in Sialkot, Pakistan — a city globally recognized for its excellence in medical instrument production. The company specializes in crafting premium-quality surgical, dental, and veterinary instruments using high-grade stainless steel and cutting-edge manufacturing technologies. With a legacy of precision, durability, and innovation, Awais Kahloo Industry is committed to delivering instruments that meet the highest international standards, ensuring accuracy, safety, and efficiency for medical professionals worldwide. The company's mission is to enhance global healthcare by providing reliable and cost-effective solutions while continuously improving through research, innovation, and customer feedback. By maintaining strict quality control, pursuing ISO and CE certifications, and focusing on sustainable manufacturing practices, Awais Kahloo Industry has earned the trust of clients across multiple continents and continues to expand its footprint in the global surgical industry.



Klein
AKI 1032
Fig 137
upper incisors



Klein
AKI 1031
Fig 6
lower molars



Klein
AKI 1033
Fig 5
lower incisors

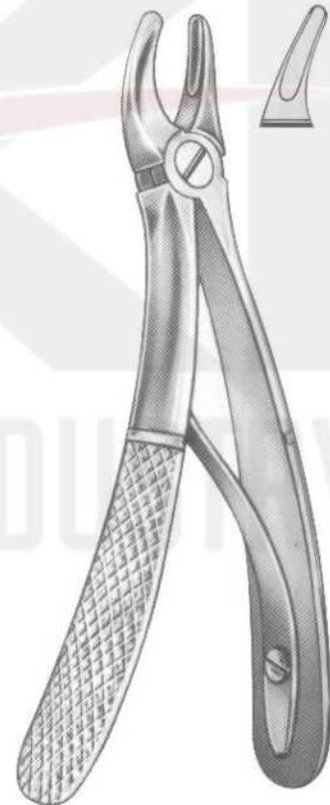

Klein
AKI 1034
Fig 139
upper premolars



AKI 1006
Fig 19
upper wisdoms

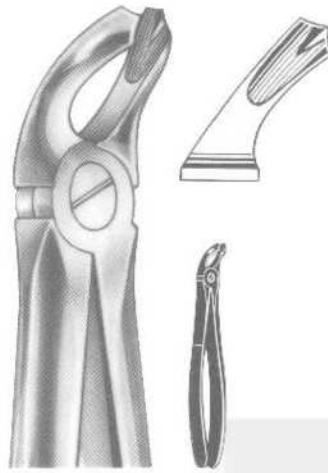

AKI 1007
Fig 20
lower wisdoms

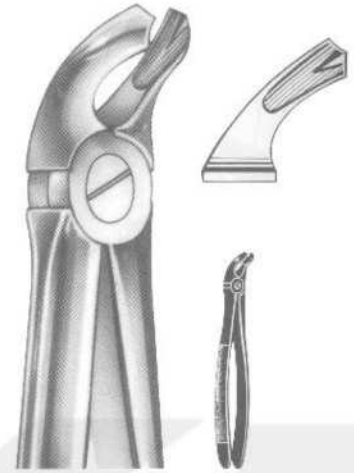

AKI 1008
Fig 21
lower molars



AKI 1009
Fig 22
lower molars

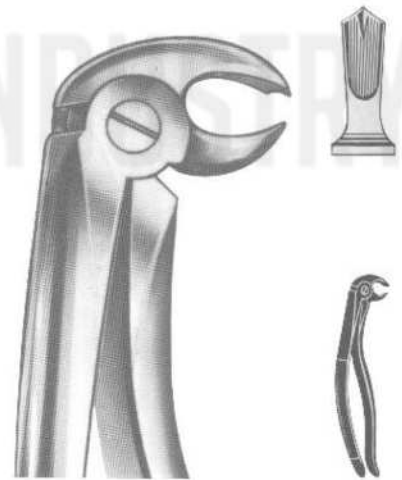

AKI 1010
Fig 22 A
Albrecht
lower molars



AKI 1011
Fig 33 A
lower roots

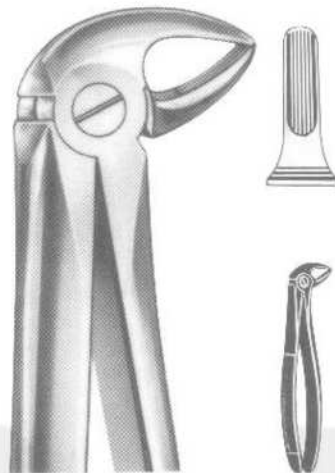

AKI 1012
Fig 33 B
lower roots

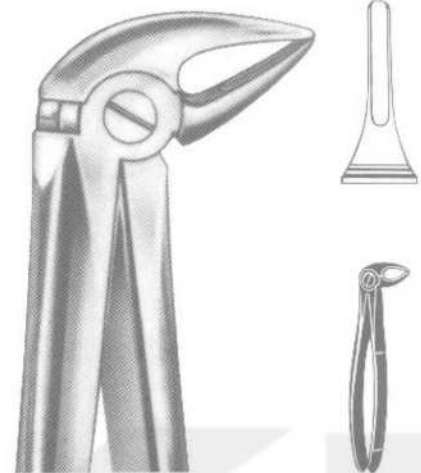

AKI 1013
Fig 33 L
lower roots



AKI 1014
Fig 33 L
lower roots



AKI 1015
Fig 33 S
lower roots, for children



AKI 1016
Fig 44
upper roots

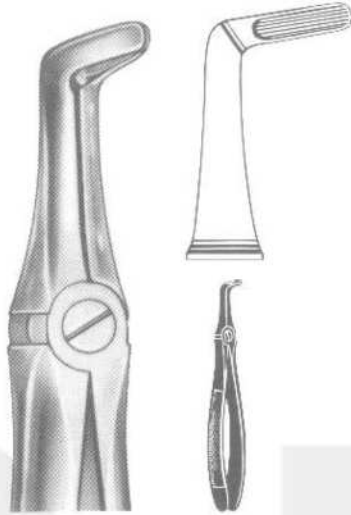

AKI 1017
Fig 45
lower roots

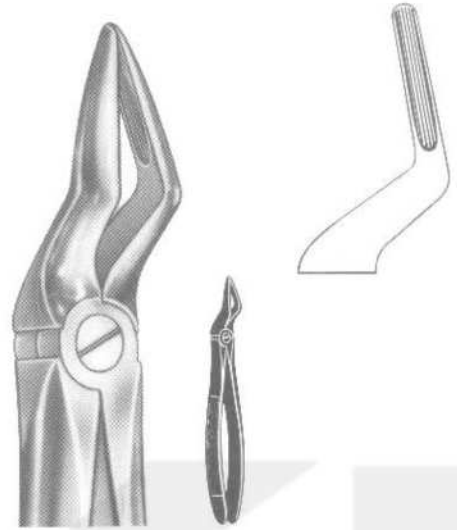

AKI 1018
Fig 12
upper roots

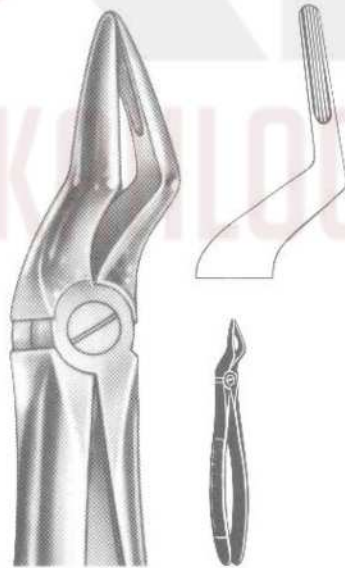

AKI 1019
Fig 51 A
upper roots

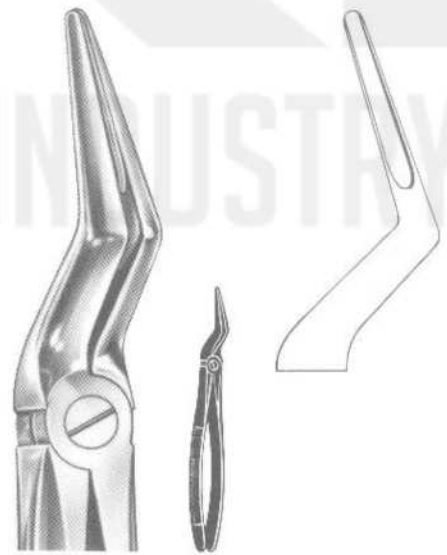

AKI 1020
Fig 51 L
upper roots



Relax
AKI 1021
Fig 51
upper roots

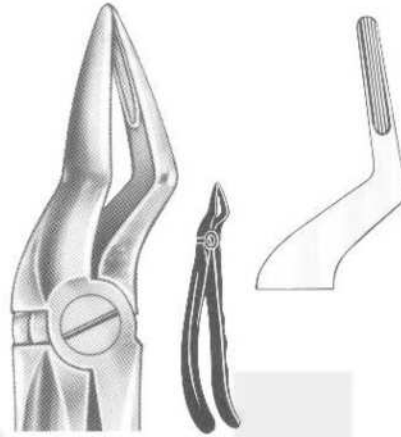

Relax
1022
Fig 51 A
upper roots

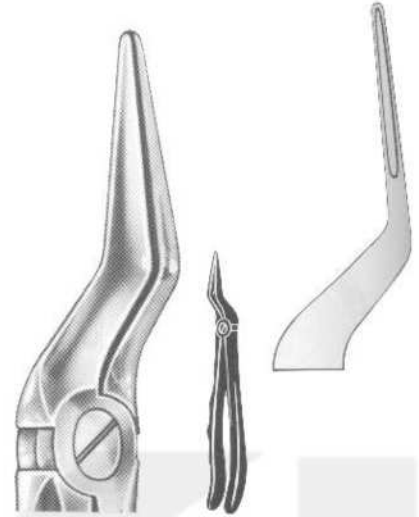

Relax
AKI 1023
Fig 51 L
upper roots

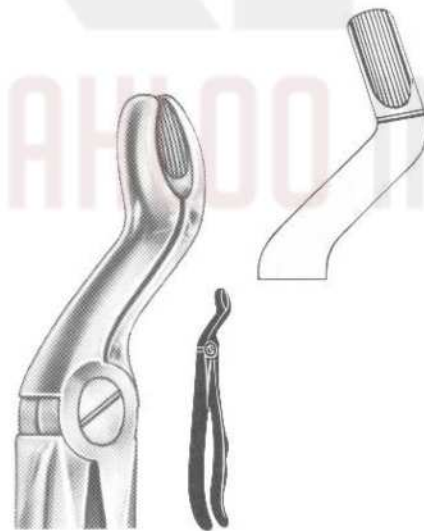

Relax
AKI 1024
Fig 67
upper wisdoms

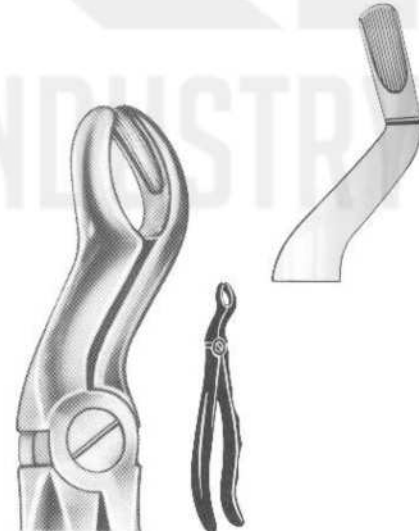

Relax
AKI 1025
Fig 67 A
upper wisdoms



AKI 1026
Fig 37
Upper incisors



WITH SERRATED TIPS

AKI 1027
Fig 39
Upper molars



WITH SERRATED TIPS

AKI 1028
Fig 39 R
Upper molars, right



WITH SERRATED TIPS

AKI 1029
Fig 39 L
Upper molars, left



WITH SERRATED TIPS

AKI 1030
Fig 515
Upper roots



Klein
AKI 1032
Fig 137
upper incisors



Klein
AKI 1031
Fig 6
lower molars



Klein
AKI 1033
Fig 5
lower incisors

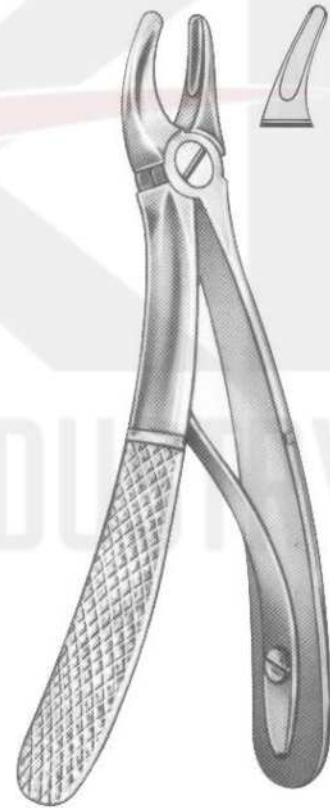

Klein
AKI 1034
Fig 139
upper premolars



AKI 1035
Fig 43 A
Fractured or decayed
upper teeth



WITH SERRATED
TIPS



AKI 1036
Fig 44
Upper roots



WITH SERRATED
TIPS

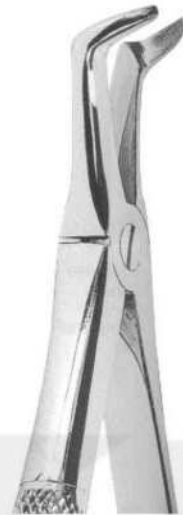

AKI 1037
Fig 45
Lower roots



WITH SERRATED
TIPS

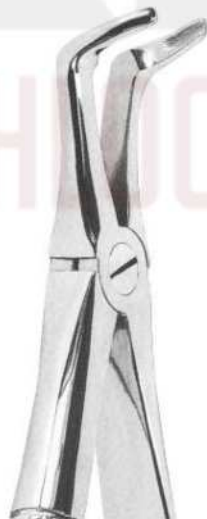

AKI 1038
Fig 46
Lower roots



WITH SERRATED
TIPS



AKI 1039
Fig 46 L
Lower roots



WITH SERRATED
TIPS



AKI 1050
Fig 59
Lower roots



AKI 1051
Fig 59 L
Lower incisor
roots



AKI 1052
Fig 60
Lower roots



AKI 1053
Fig 65 L
Upper molars, left



AKI 1054
Fig 65 R
Upper molars, right





AKI 1055
Fig 66 L
Upper molars, left



AKI 1056
Fig 66 R
Upper molars, right



WITH SERRATED TIPS



AKI 1057
Fig 67
Upper three molars



WITH SERRATED TIPS



AKI 1058
Fig 67 A
Upper third molars



WITH SERRATED TIPS



AKI 1059
Fig 68
Lower roots



WITH SERRATED TIPS



AKI 1060
Fig 67½ L
Upper third molars, left



AKI 1061
Fig 67½ R
Upper third molars, right

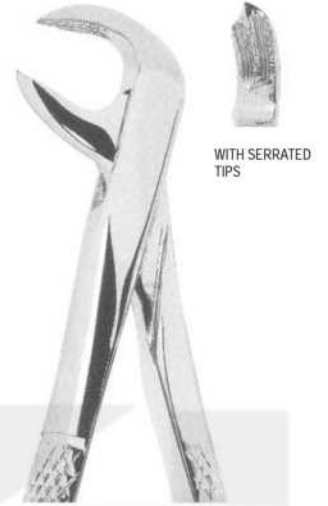

AKI 1062
Fig 73
Lower molars



AKI 1063
Fig 74
Lower roots

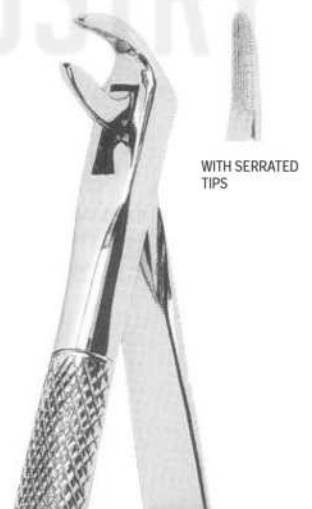

AKI 1064
Fig 74 M
Lower roots



AKI 1065
Fig 74 N
Lower roots



AKI 1066
Fig 75
Lower canines and
premolars

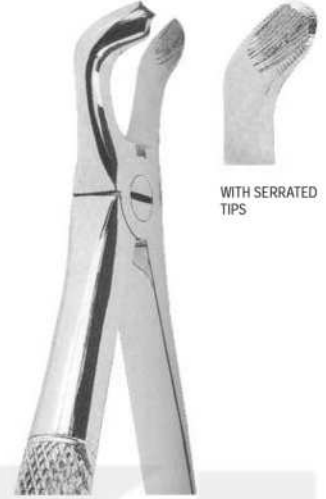

AKI 1067
Fig 79
Lower third molars

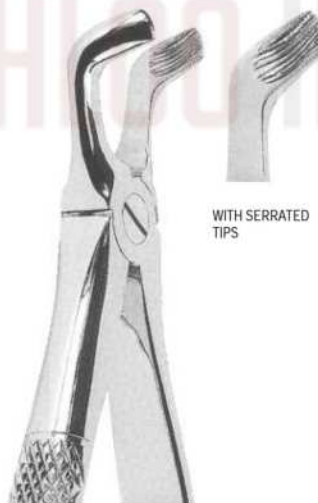

AKI 1068
Fig 79 A
Lower third molars



AKI 1069
Fig 79 C
Lower third molars

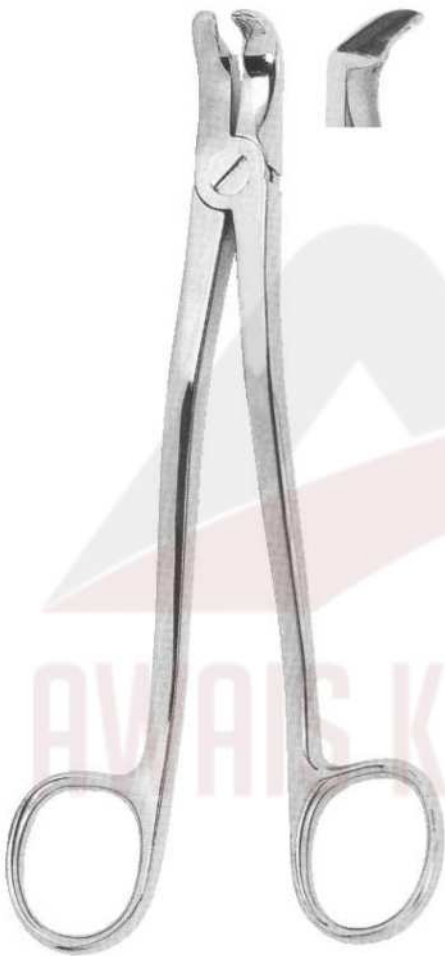

AKI 1070
Fig 86 W
Lower third molars



AKI 1071
Fig 86 1/2 L
Lower third molars, left



AKI 1072
Fig 86 1/2 R
Lower third molars, right



AKI 1073
Fig 86 C
Lower molars



AKI 1074
Fig 87
Lower decayed molars
or broken-down crowns



WITH SERRATED
TIPS

AKI 1075
Fig 89
Upper molars, right



WITH SERRATED
TIPS

AKI 1076
Fig 90
Upper molars, left



WITH SERRATED
TIPS

AKI 1077
Fig 99
Broken-down lower molars

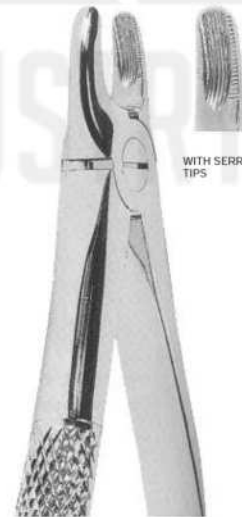

WITH SERRATED
TIPS

AKI 1078
Fig 107
Upper canines



AKI 1079
Fig 121
Upper third molars

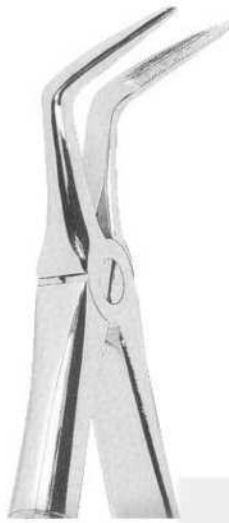

AKI 1080
Fig 145
Lower roots



WITH SERRATED TIPS



AKI 1081
Fig 151 $\frac{1}{2}$
Upper roots



WITH SERRATED TIPS



AKI 1082
Fig 166
Universal extracting forceps for
upper teeth, in particular molars
and premolars



WITH SERRATED TIPS



AKI 1083
Fig 167
Universal extracting forceps for
lower teeth, in particular molars
and premolars



WITH SERRATED TIPS



AKI 1084
Fig 168
Upper canines

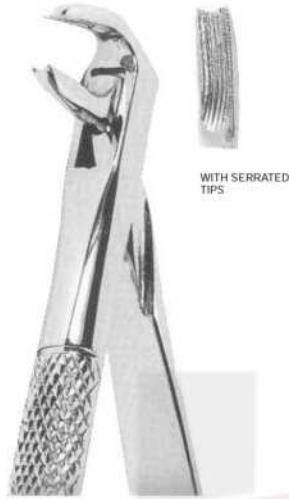

AKI 1085
Fig 169
Lower canines

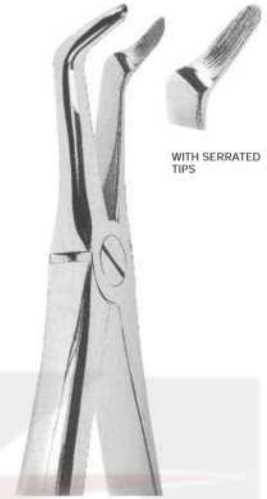

AKI 1086
Fig 346
Lower roots



AKI 1087
Fig 349
Upper roots



AKI 1088
Fig 359
Lower roots



AKI 1089
Fig 1
Universal extracting forcep for
upper incisors and canines



WITH SERRATED
TIPS



AKI 1090
Fig 2
Upper molars



WITH SERRATED
TIPS

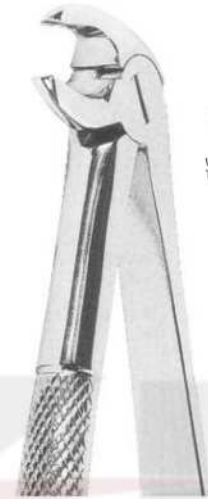

AKI 1091
Fig 3
Lower incisors, premolar
and roots



WITH SERRATED
TIPS



AKI 1092
Fig 4
Lower molars



WITH SERRATED
TIPS



AKI 1093
Fig 1
Upper incisors
and canines

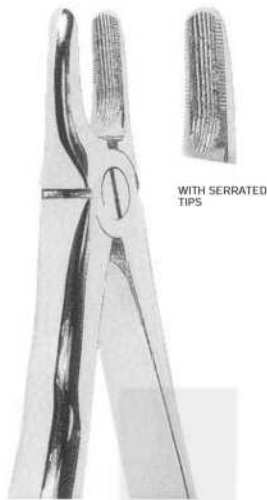

AKI 1094
Fig 2
Upper incisors
and canines

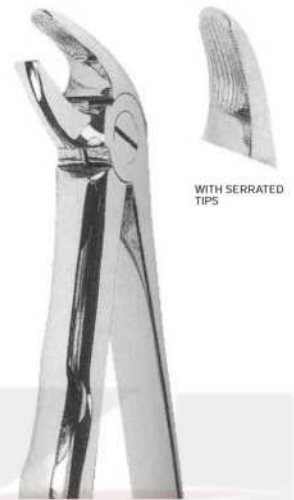

AKI 1095
Fig 4
Lower incisors
and canines

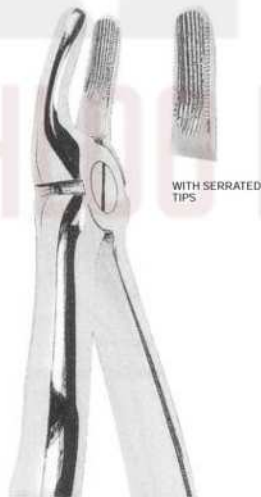

AKI 1096
Fig 7
Upper premolars



AKI 1097
Fig 13
Lower premolars

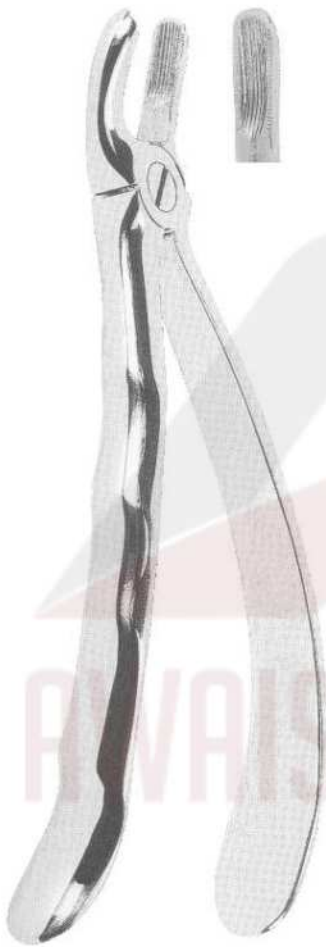

AKI 1098
Fig 17
Upper molars, right

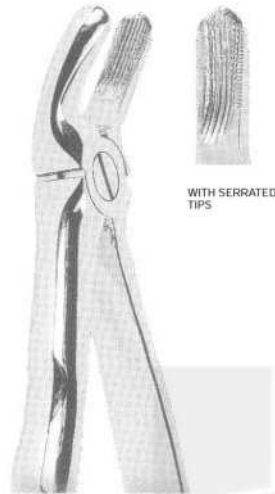

AKI 1099
Fig 18
Upper molars, left

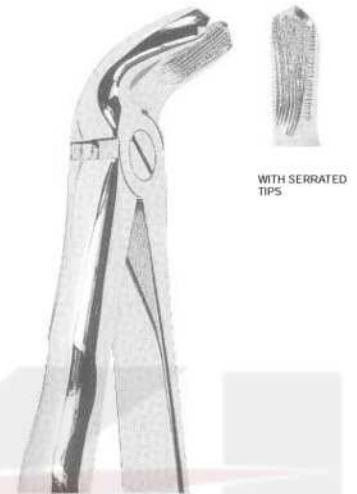

AKI 1100
Fig 21
Lower molars



AKI 1101
Fig 22
Lower molars



AKI 1102
Fig 33
Lower roots



AKI 1110
Fig 89
Upper molars, right

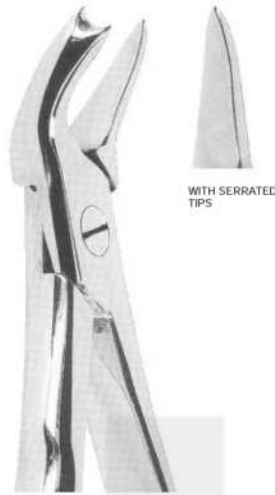

AKI 1111
Fig 90
Upper molars, left

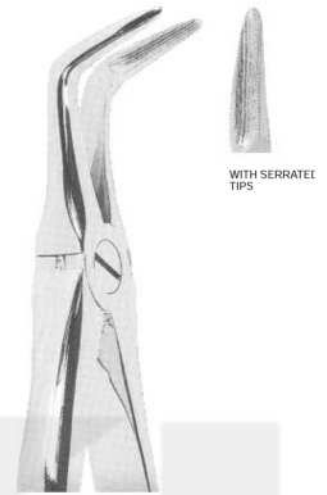

AKI 1112
Fig 145
Lower roots



AKI 1113
Fig 151 1/2
Upper roots

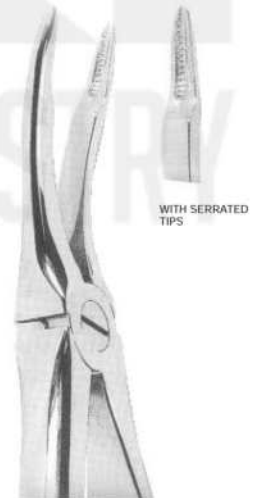

AKI 1114
Fig 349
Upper roots

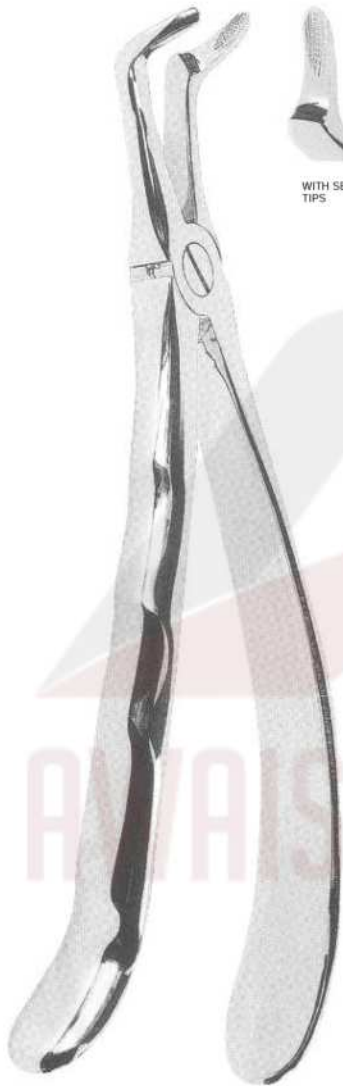

AKI 1103
Fig 45
Lower roots



WITH SERRATED TIPS



AKI 1104
Fig 51 A
Upper roots

WITH SERRATED TIPS



AKI 1105
Fig 67 A
Upper third molars

WITH SERRATED TIPS



AKI 1106
Fig 74
Lower roots

WITH SERRATED TIPS



AKI 1107
Fig 79
Lower third molars

WITH SERRATED TIPS



AKI 1108
Fig 86 C
Lower molars

WITH SERRATED TIPS



AKI 1109
Fig 359
Lower roots

WITH SERRATED TIPS



AKI 1115
Fig 5
Lower third molars

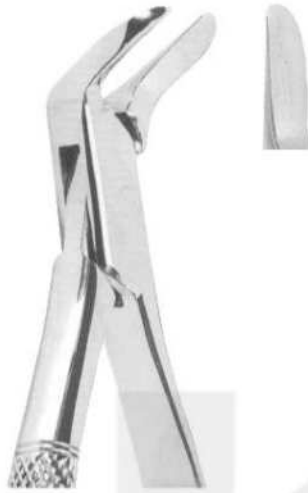

AKI 1116
Fig 6
Separating forceps



AKI 1117
Fig 105
Upper molars



AKI 1118
Fig 16
Lower molars



AKI 1119
Fig 17
Lower molars



AKI 1120
Fig 18 L
Upper molars, left

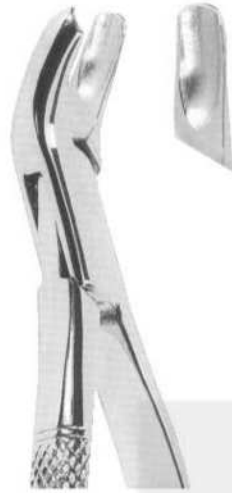

AKI 1121
Fig 18 R
Upper molars, right



AKI 1122
Fig 23
Lower molars



AKI 1123
Fig 53 R
Upper molars, right



AKI 1124
Fig 53 L
Upper molars, left



AKI 1125
Fig 65
Upper incisors and roots



AKI 1126
Fig 69
Upper and lower roots



AKI 1127
Fig 88 R
Upper molars, right



AKI 1128
Fig 88 L
Upper molars, left



AKI 1129
Fig 101
Deciduous teeth

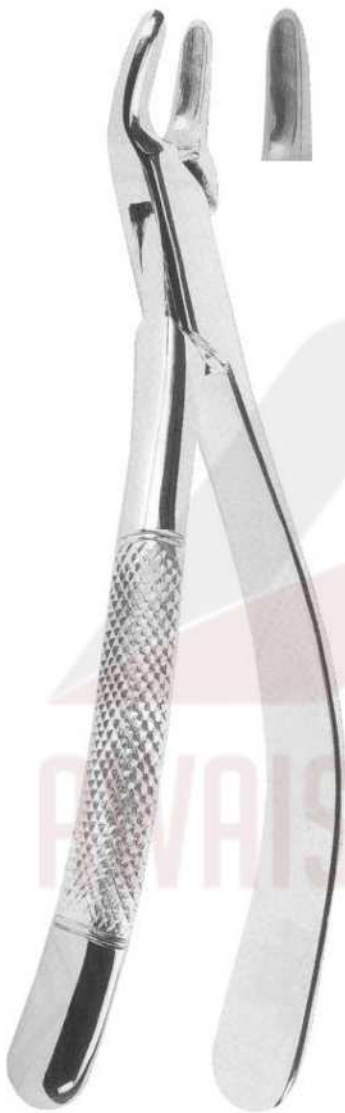

AKI 1130
Fig 150
Upper incisors, premolars, roots



AKI 1131
Fig 150 S
Upper teeth (for children)

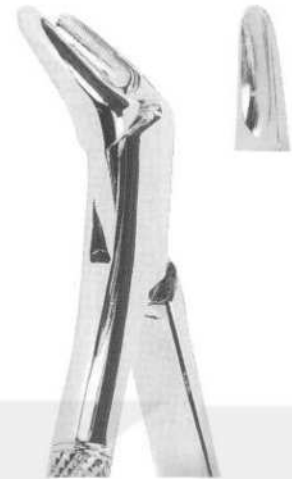

AKI 1132
Fig 151
Upper incisors, premolars, roots



AKI 1133
Fig 151S
Lower teeth (for children)



AKI 1134
Fig 222
Lower third molars



AKI 1135
Fig 1
upper incisors and bicuspid

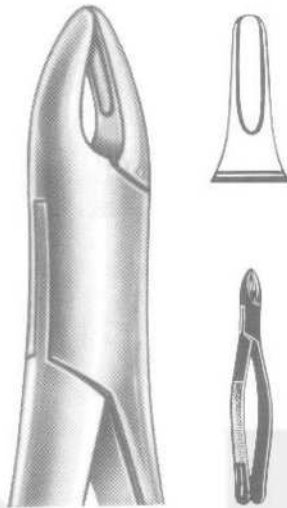

AKI 1136
Fig 1 B
upper roots, anterior



Physick
AKI 1137
Fig 5
lower wisdoms

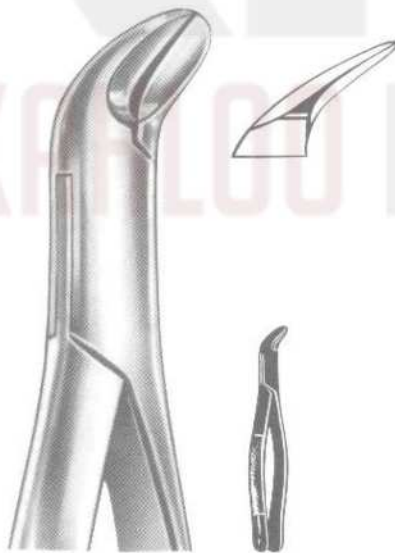

AKI 1138
Fig 6
lower molars, splitting forceps



AKI 1139
Fig 10 H
upper molars



AKI 1140
Fig 135
Lower premolars



WITH SERRATED
TIPS



AKI 1141
Fig 225
Lower molars



AKI 1142
Fig 305
Upper incisors
and roots



AKI 1143
Fig 33 S
Lower roots



WITH SERRATED
TIPS



AKI 1144
Fig 38
Lower incisors
and canines



WITH SERRATED
TIPS



AKI 1145
Fig 1
Upper incisors



WITH SERRATED TIPS



1146
Fig 2
Upper premolars



WITH SERRATED TIPS



1147
Fig 3
Upper molars



WITH SERRATED TIPS



AKI 1148
Fig 4
Upper roots



WITH SERRATED TIPS



AKI 1149
Fig 5
Lower incisors



WITH SERRATED TIPS



AKI 1150
Fig 6
Lower molars



WITH SERRATED TIPS



AKI 1151
Fig 7
Lower roots



WITH SERRATED TIPS



AKI 1152
Fig 1
Lower roots



WITH SERRATED TIPS



AKI 1153
Fig 2
Upper roots



WITH SERRATED TIPS



AKI 1155
Fig 2
Roots fragments



AKI 1154
Fig 1
Roots fragments

lower jaw, left side

lower jaw, right side

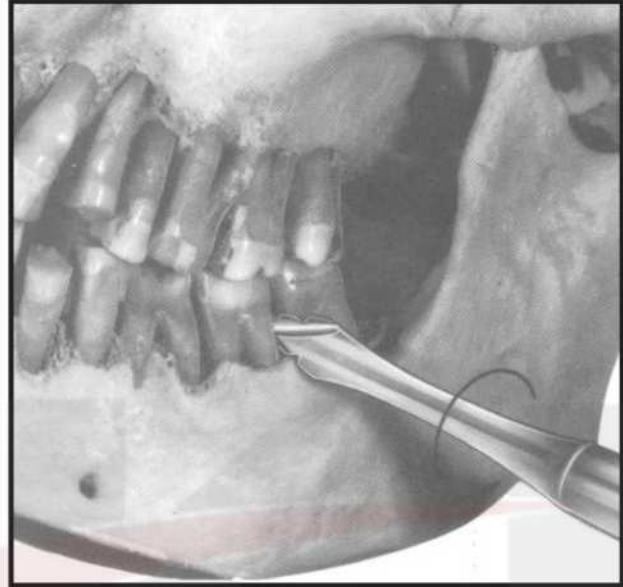

Root elevator, spiral-shaped, for extremely facilitated extraction of the molars in the lower jaw. The slender, conical points allow deep penetration between tooth and gum. Owing to the hook-shaped working parts, slipping of the elevator is avoided.



AKI 1200



AKI 1201



Bein

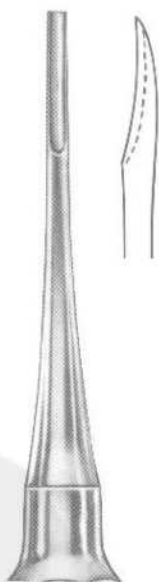

Bein
AKI 1202
Fig 1

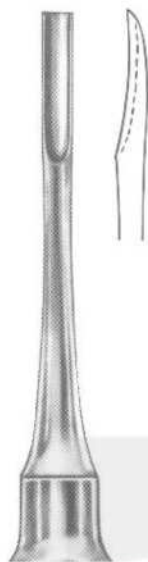

Bein
AKI 1203
Fig 2

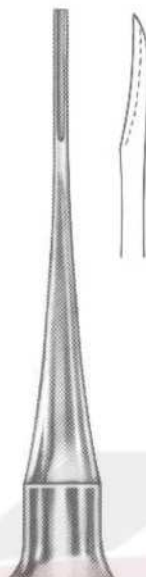

Bein
AKI 1204
Fig 0



Bein
AKI 1205
Fig 3

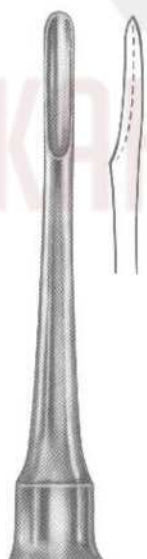

Bein
AKI 1206
Fig 4



Bein
AKI 1207
Fig 5



Bein
AKI 1208
Fig 6













Kopp
AKI 1237
Fig 1



Kopp
AKI 1238
Fig 2



Kopp
AKI 1243
Fig 1



Kopp
AKI 1244
Fig 2



Kopp



Kopp
AKI 1239
Fig 3



Kopp
AKI 1240
Fig 4



Kopp



Kopp
AKI 1245
Fig 3



Kopp
AKI 1246
Fig 4



Kopp
AKI 1241
Fig 5



Kopp
AKI 1242
Fig 6

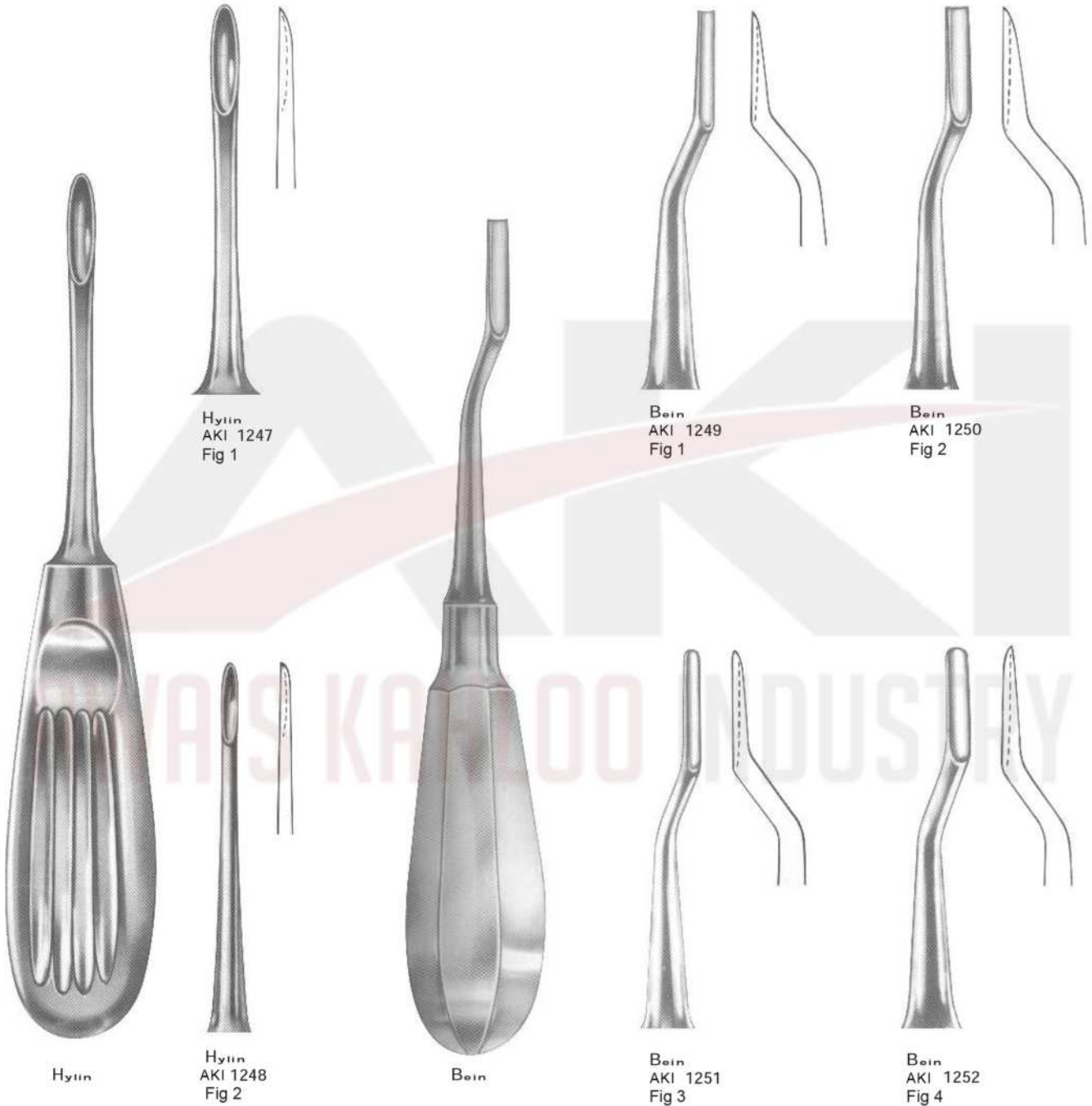





Pott



Pott
AKI 1260
Fig 1

Pott
AKI 1261
Fig 2



AKI 1262
Fig 1



AKI 1263
Fig 2

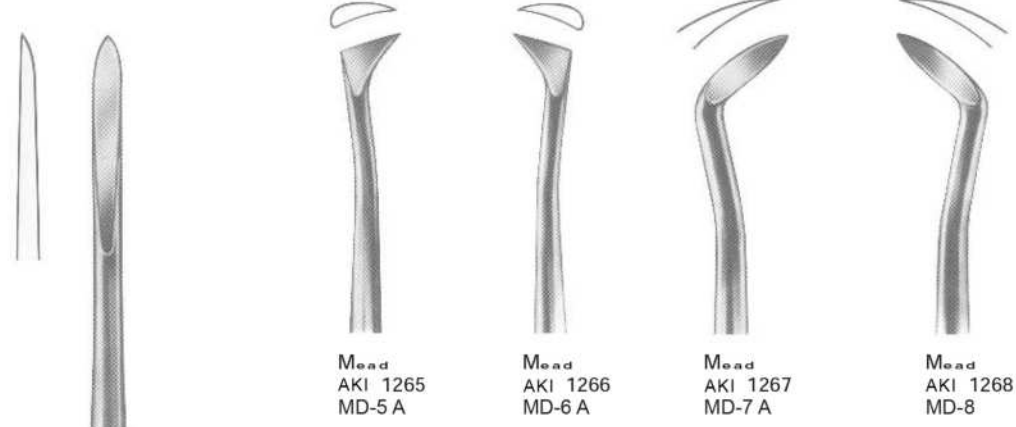



Chompret
AKI 1270
Fig 1



Chompret
AKI 1271
Fig 2



Chompret
AKI 1272
Fig 3



Chompret
AKI 1273
Fig 4



Apicat
AKI 1274



AKI 1275
Fig 1



AKI 1276
Fig 2



AKI 1277
Fig 3



Heidbrink
AKI 1278
Fig 1



Heidbrink
AKI 1279
Fig 2



Heidbrink
AKI 1280
Fig 3



Winter
AKI 1281
Fig 1L



Winter
AKI 1282
Fig 1R



Winter
AKI 1283
Fig 2L



Winter
MJS-1284
Fig 2R



Winter
AKI 1285
Fig 11 L



Winter
AKI 1286
Fig 11 R



Winter
AKI 1287
Fig 12 L



Winter
AKI 1288
Fig 12 R



Winter



Winter
AKI 1289
Fig 14 I



Winter
AKI 1290
Fig 14R



Barry
AKI 1291
Fig 1



Barry
AKI 1292
Fig 2



Barry
AKI 1293
Fig 3



Barry
AKI 1294
Fig 4



Barry



Barry
AKI 1295
Fig 11



Barry
AKI 1296
Fig 12



Barry
AKI 1297
Fig 17



Barry
AKI 1298
Fig 18



Cryer
AKI 1300
Fig 26

Seldin
AKI 1301
Fig 27

Cryer
AKI 1302
Fig 28

Cryer
AKI 1303
Fig 29

Heidbrink
AKI 1304
Fig 22

Heidbrink
AKI 1305
Fig 23



AKI 1299

Fig 17

Fig 18



Kopp
AKI 1307
Fig 31



Kopp
AKI 1308
Fig 32



Kopp
AKI 1309
Fig 33



Kopp
AKI 1310
Fig 34



Kopp
AKI 1311
Fig 35



Kopp
AKI 1312
Fig 44



AKI 1306



Heidbrink
AKI 1314
Fig 10



Winter
AKI 1315
Fig 11



Winter
AKI 1316
Fig 12



Barry
AKI 1317
Fig 17



Barry
AKI 1318
Fig 18



AKI 1319
Fig 20



AKI 1313

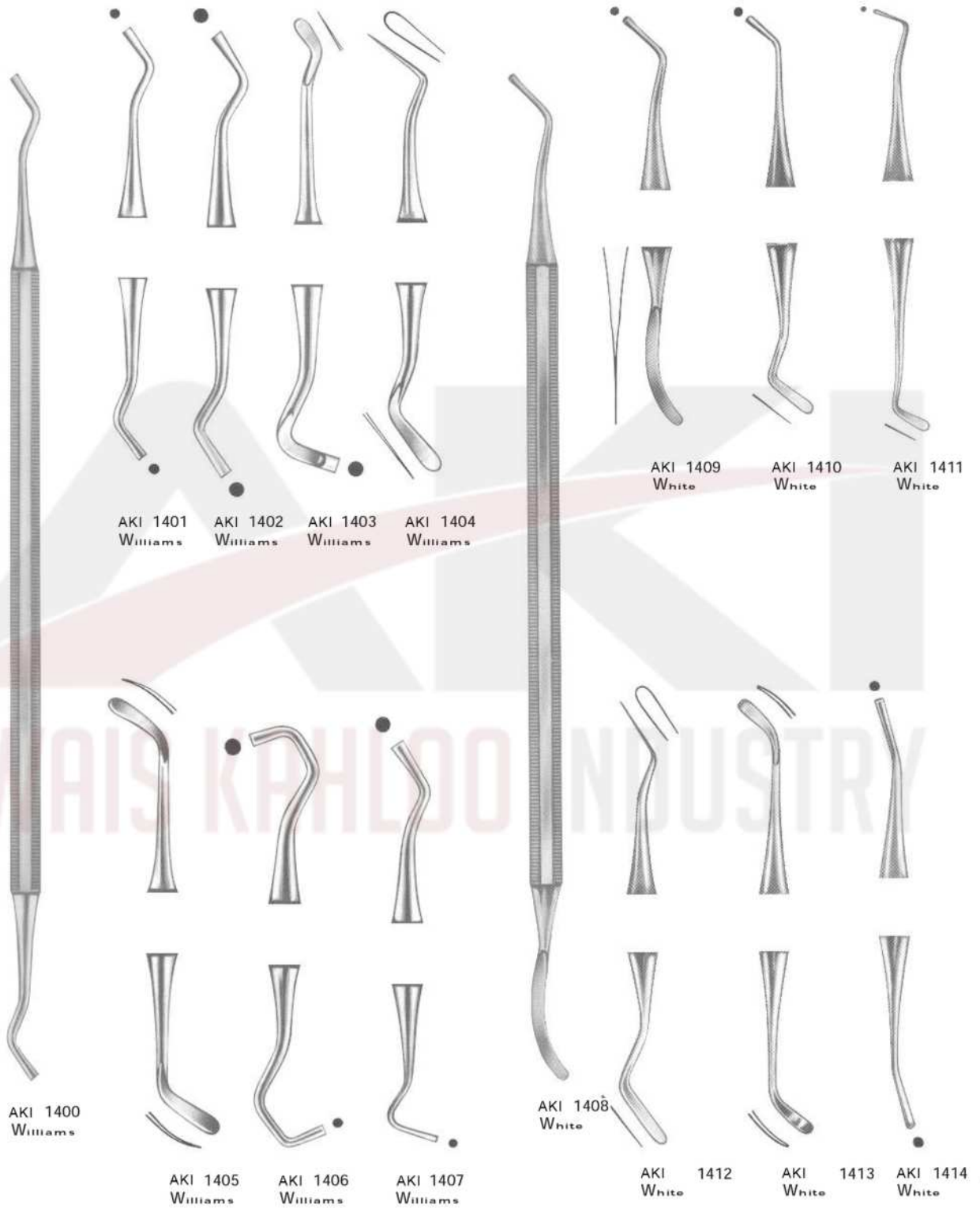

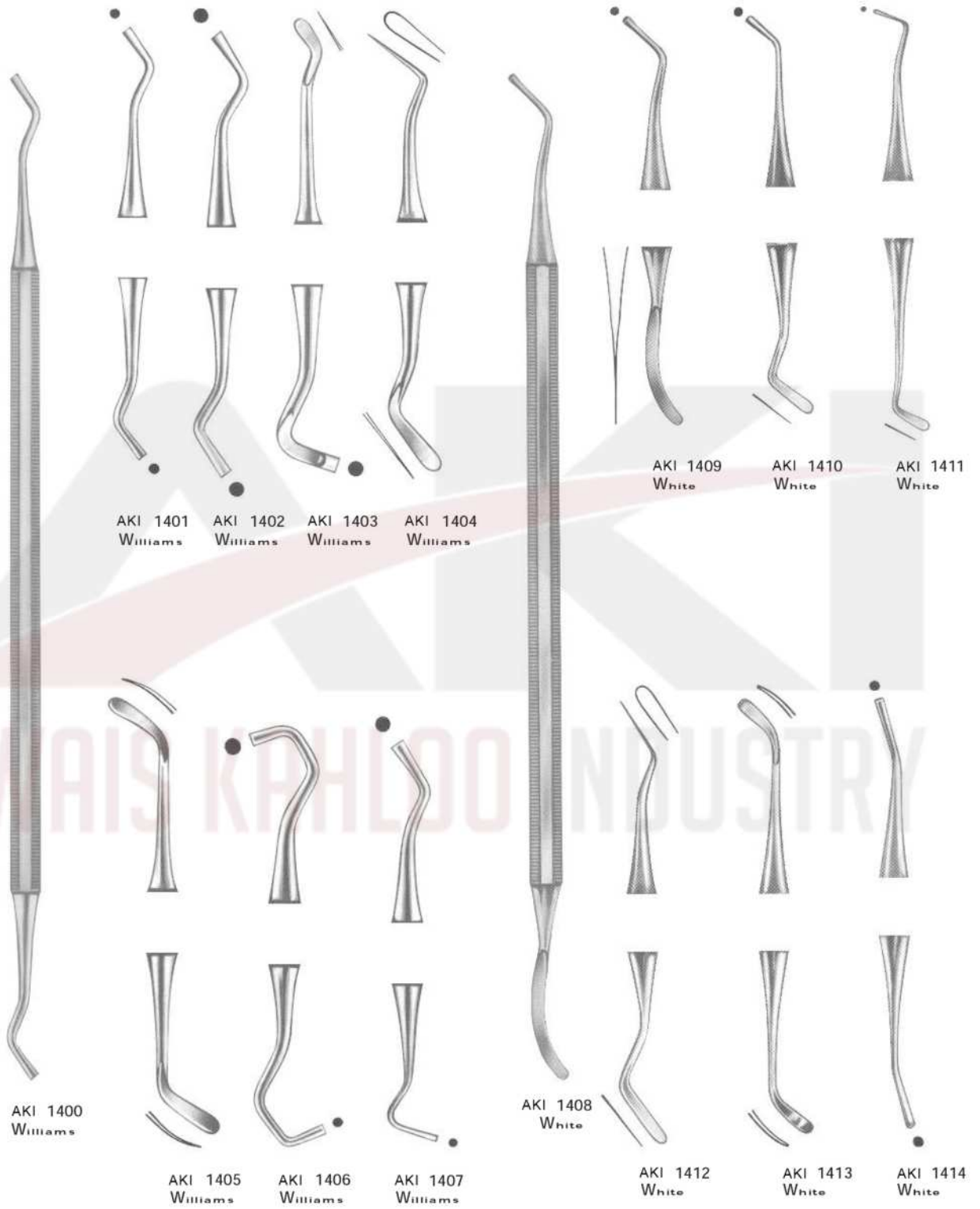

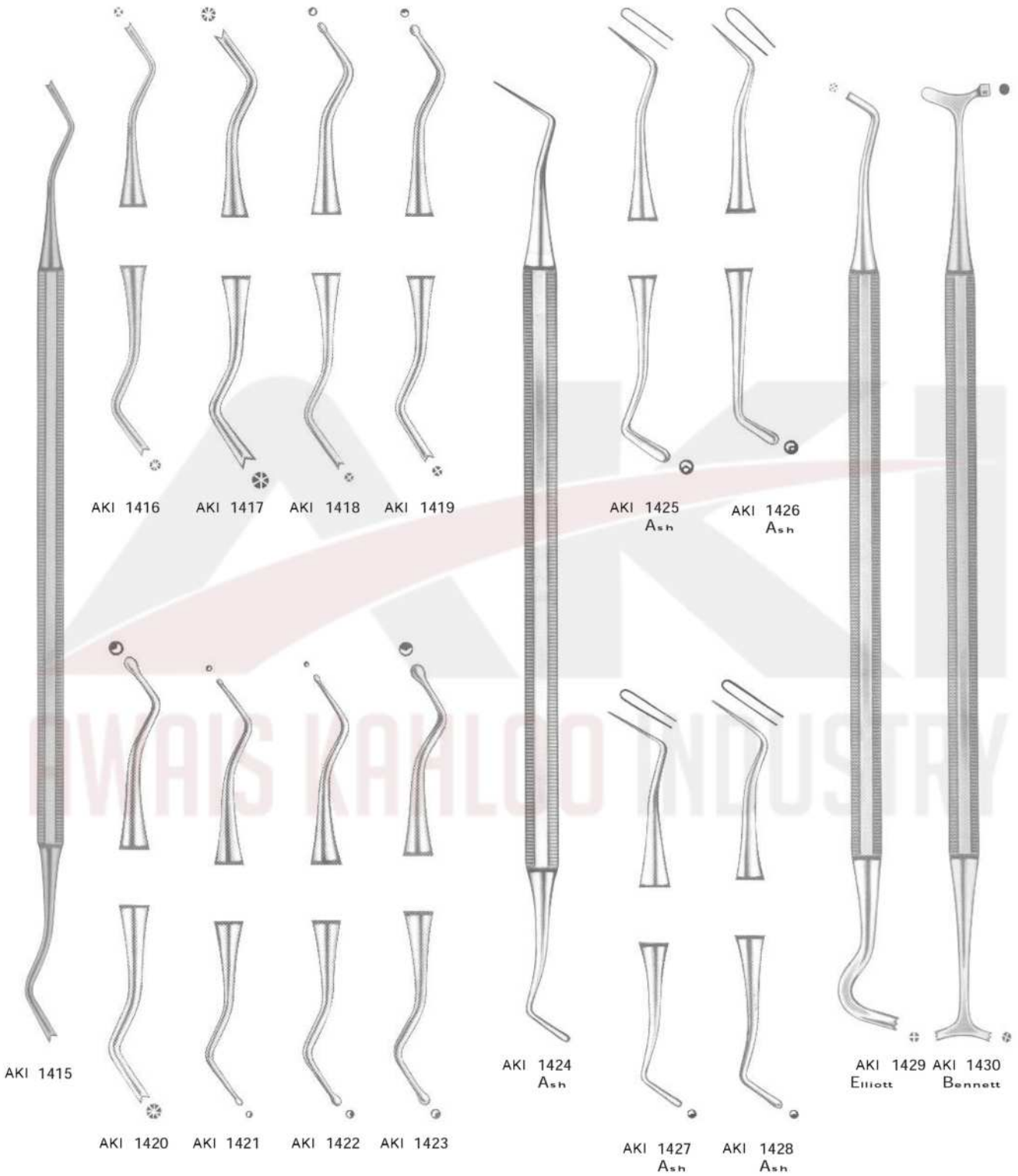



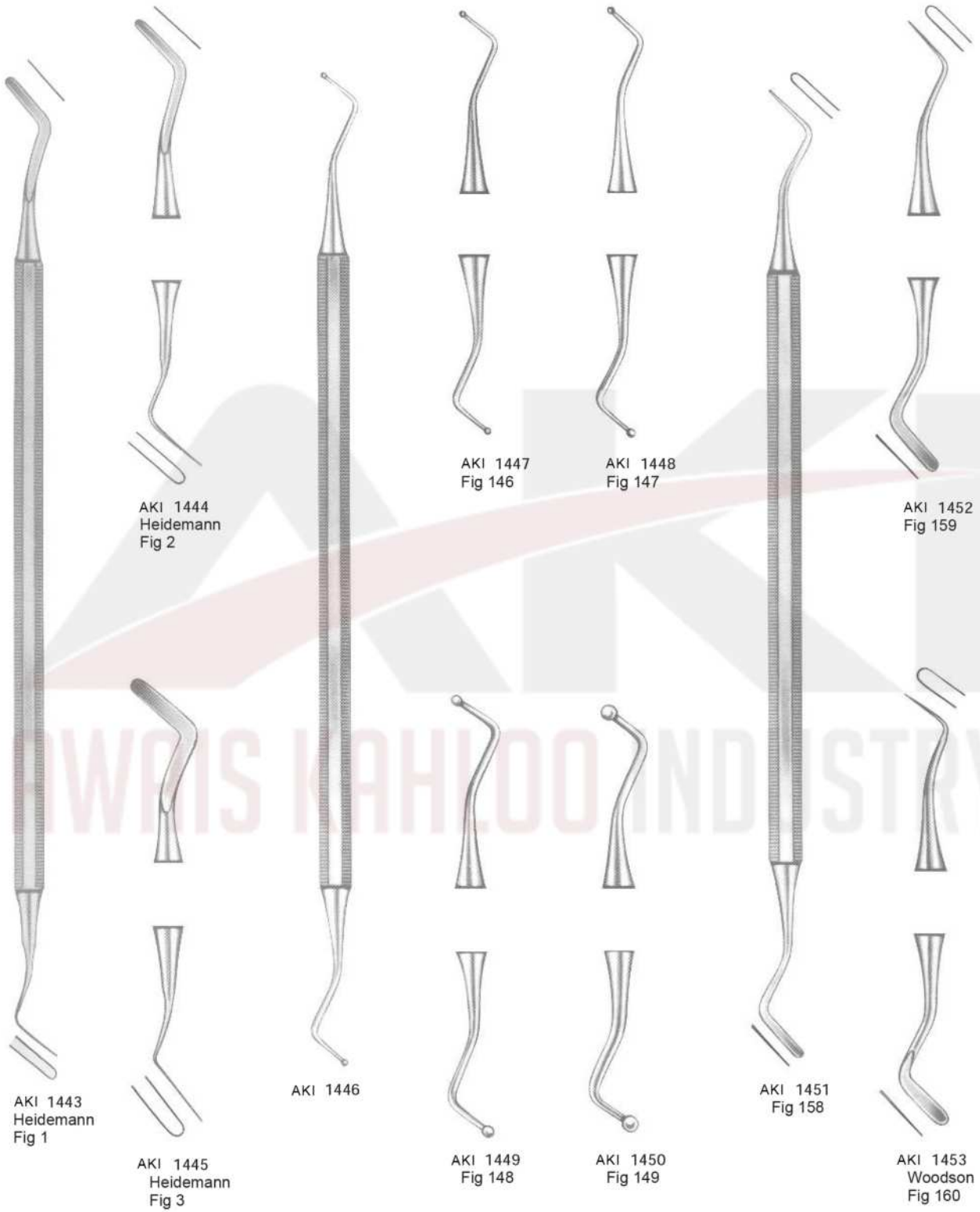



AKI 1454
Gracey



AKI 1455
Gracey
Fig 1

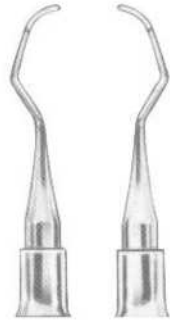

AKI 1456
Gracey
Fig 2



AKI 1457
Gracey
Fig 3

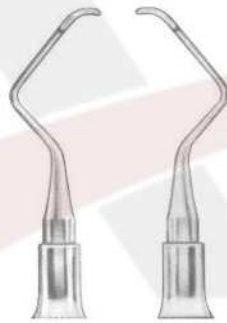

AKI 1458
Gracey
Fig 4



AKI 1459
Gracey
Fig 5

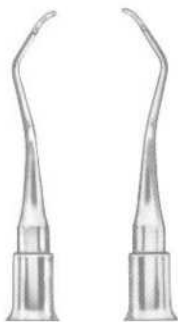

AKI 1460
Gracey
Fig 6



1461



AKI 1462-1
Fig 18



AKI 1463-2
Fig 19



AKI 1464-3
Fig 20



AKI 1465-4
Fig 22



AKI 1466-5
Fig 23



AKI 1467-6
Fig 25



AKI 1468-7
Fig 26



AKI 1469-8
Fig 27

With Point Set In



AKI 1470



AKI 1471-1



AKI 1472-2



AKI 1473-3



AKI 1474-4



AKI 1475-5



AKI 1476-6



MJS-1477-7



AKI 1478-8



AKI 1479-9



AKI 1480-10



AKI 1481-11



AKI 1482-2
Woodson

Polishing Instruments

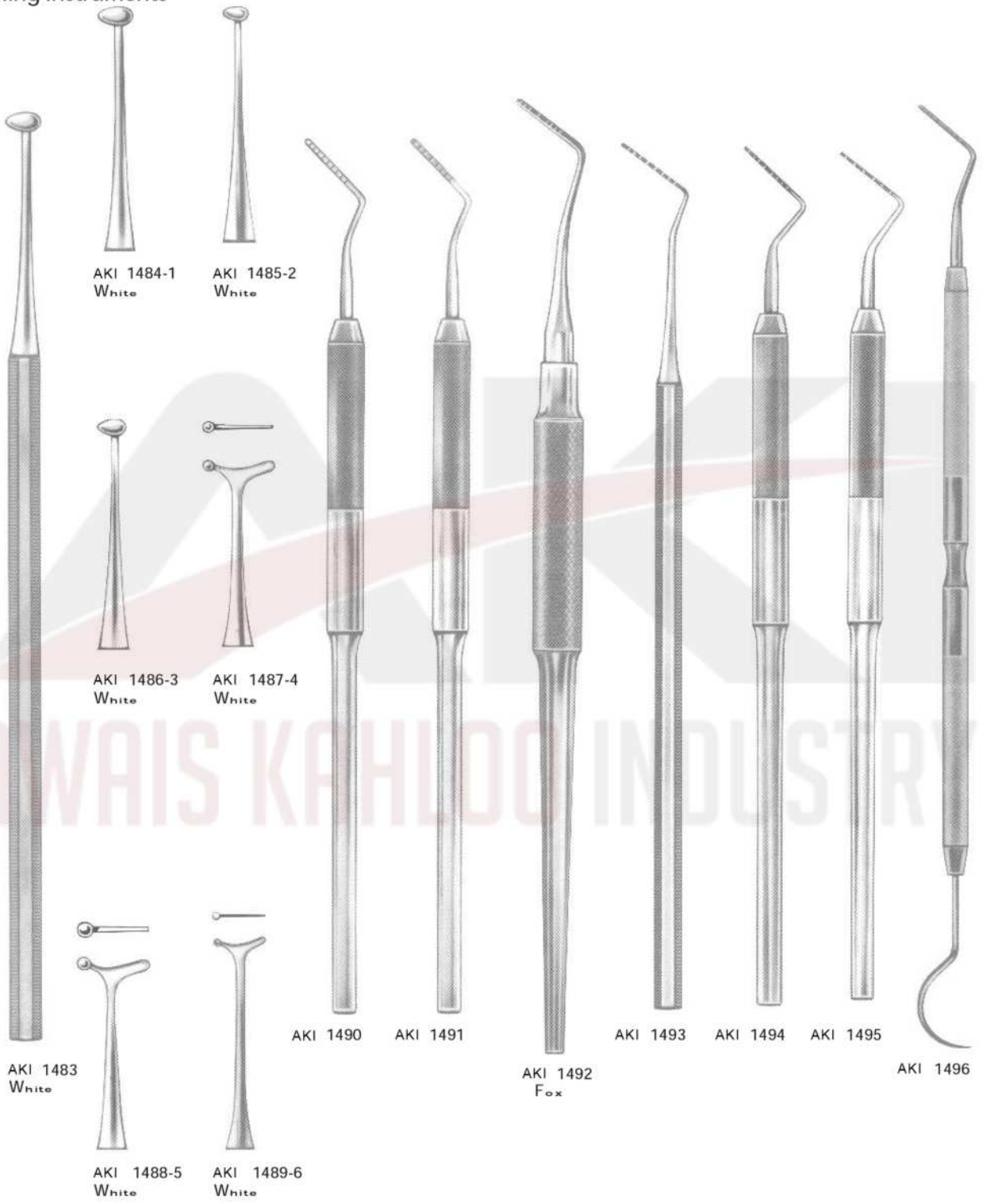



- New marking process.
- Laser system marking.
- No more paint peeling off.
- Permanent marking.
- Antiglare, low depth marking.
- Maximum tip resistance against breaking.



AKI 1497
Fig CP-C

AKI 1498
Fig CP-11

AKI 1499
Fig CP-12

AKI 1500
Fig CP-12S
O.M.S



Fires

Chisels

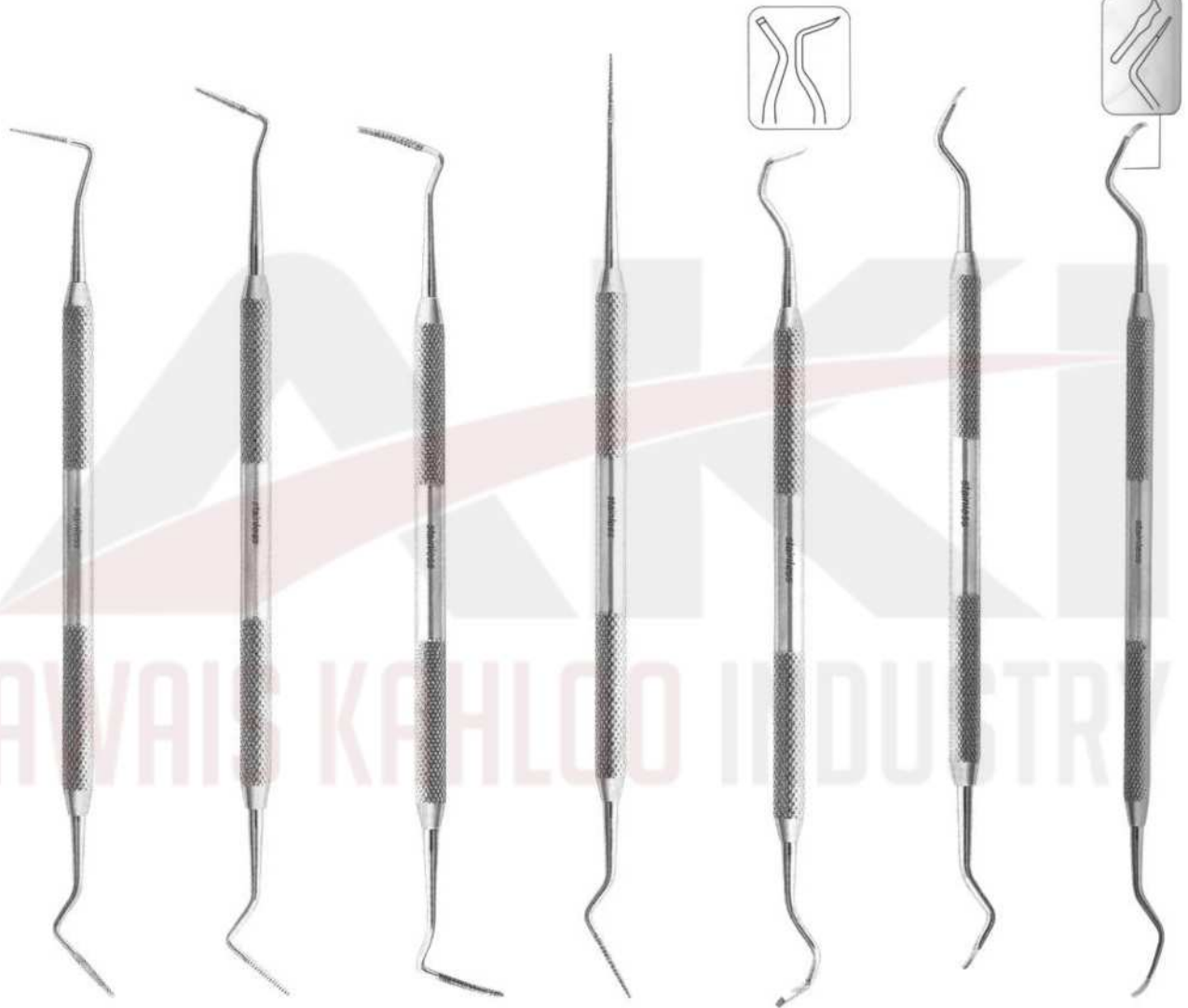

AKI 1507
Sugarman
Fig. 1S/2S

AKI 1508
Sugarman
Fig. 3S/4S

AKI 1509
Schluger
Fig. 9/10

AKI 1510
Buck
Fig. 11/12

AKI 1511
Ochsenbein
Fig. 3

AKI 1512
Ochsenbein
Fig. 4

AKI 1513
Rhodes
Back - Action
Fig. 36/37

Files

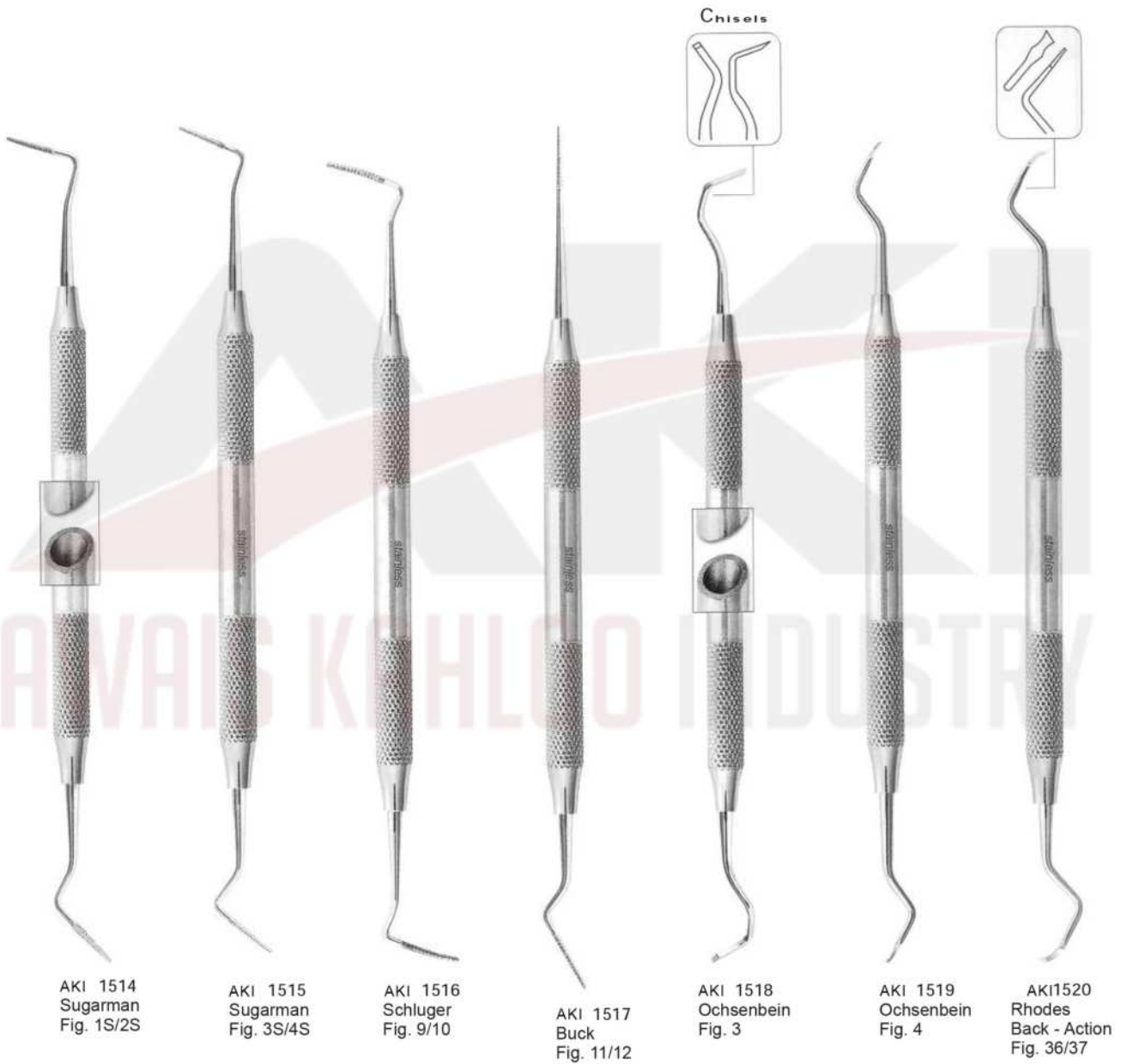

AKI 1514
Sugarman
Fig. 1S/2S

AKI 1515
Sugarman
Fig. 3S/4S

AKI 1516
Schluger
Fig. 9/10

AKI 1517
Buck
Fig. 11/12

AKI 1518
Ochsenbein
Fig. 3

AKI 1519
Ochsenbein
Fig. 4

AKI1520
Rhodes
Back - Action
Fig. 36/37

Gingivectomy knives



AKI 1521
Goldman-Fox
Fig. 7



AKI 1522
Goldman-Fox
Fig. 8



AKI 1523
Goldman-Fox
Fig. 9



AKI 1524
Goldman-Fox
Fig. 11



AKI 1525
Buck
Fig. 3/4



AKI 1526
Buck
Fig. 5/6

Curettes and Scalers

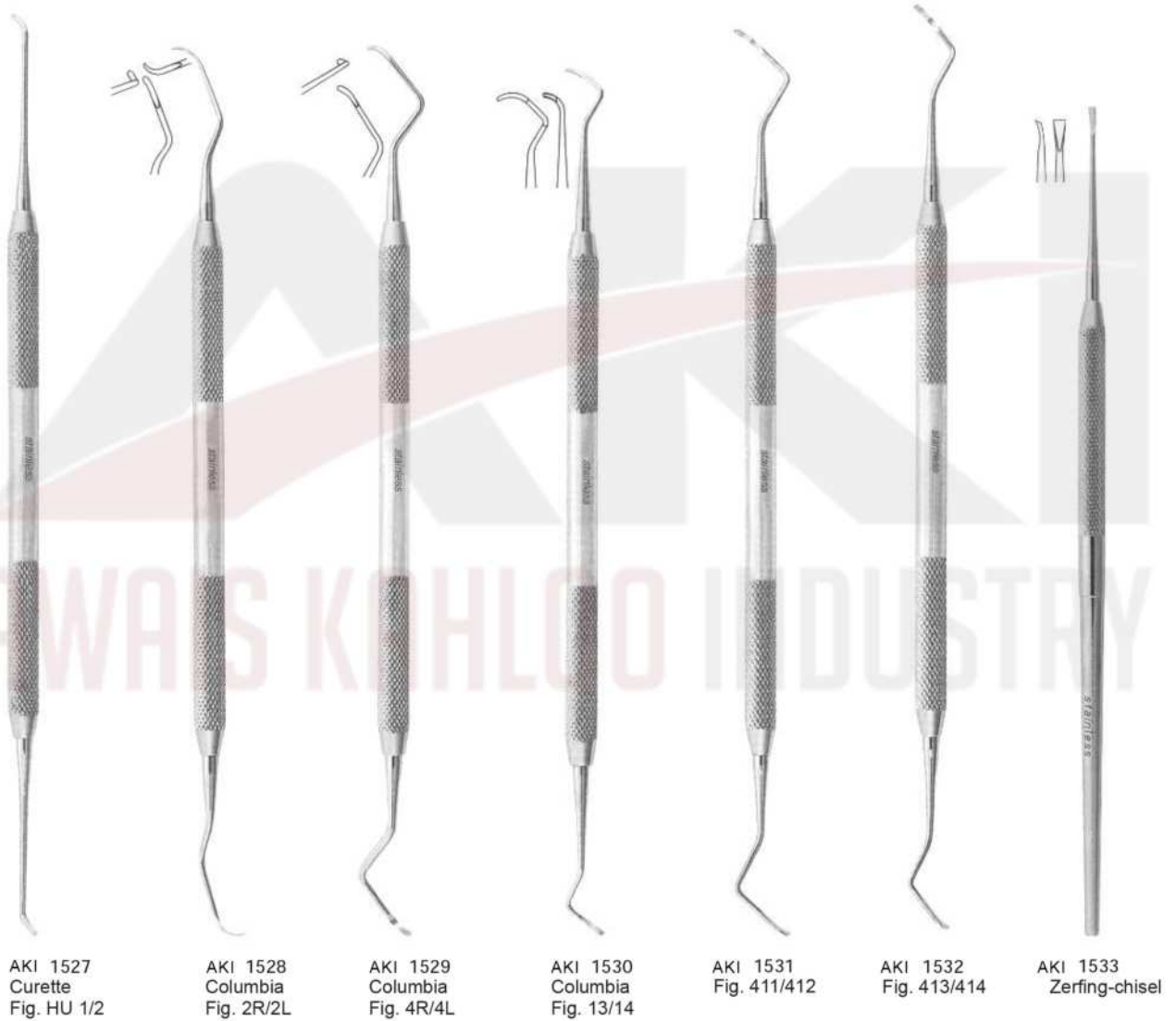

Gingivectomy knives

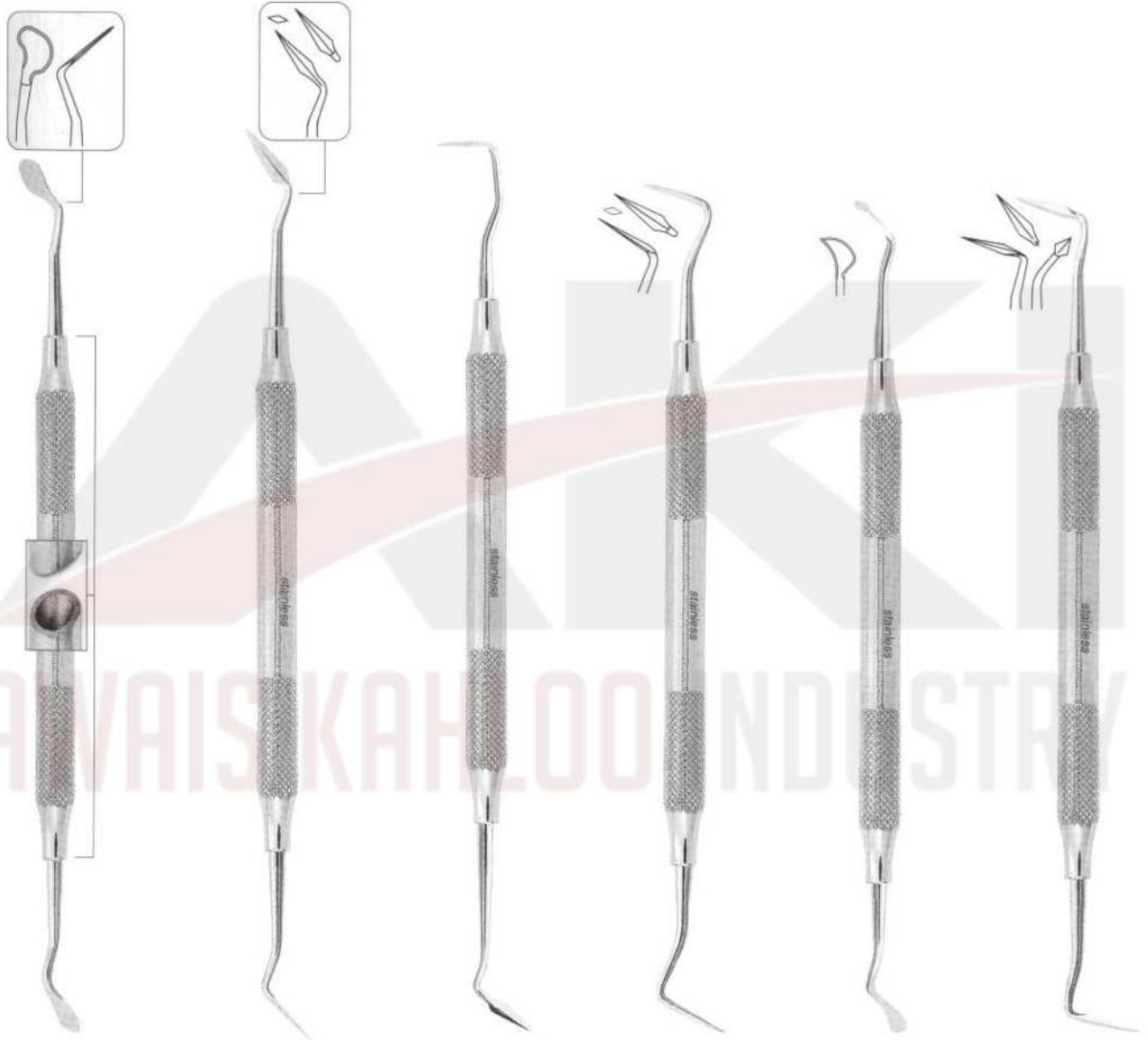

AKI 1534
Goldman - Fox
Fig. 7

AKI 1535
Goldman - Fox
Fig. 8

AKI 1536
Goldman - Fox
Fig. 9

AKI 1537
Goldman - Fox
Fig. 11

AKI 1538
Buck
Fig. 3/4

AKI 1539
Buck
Fig. 5/6

Curettes and Scalers

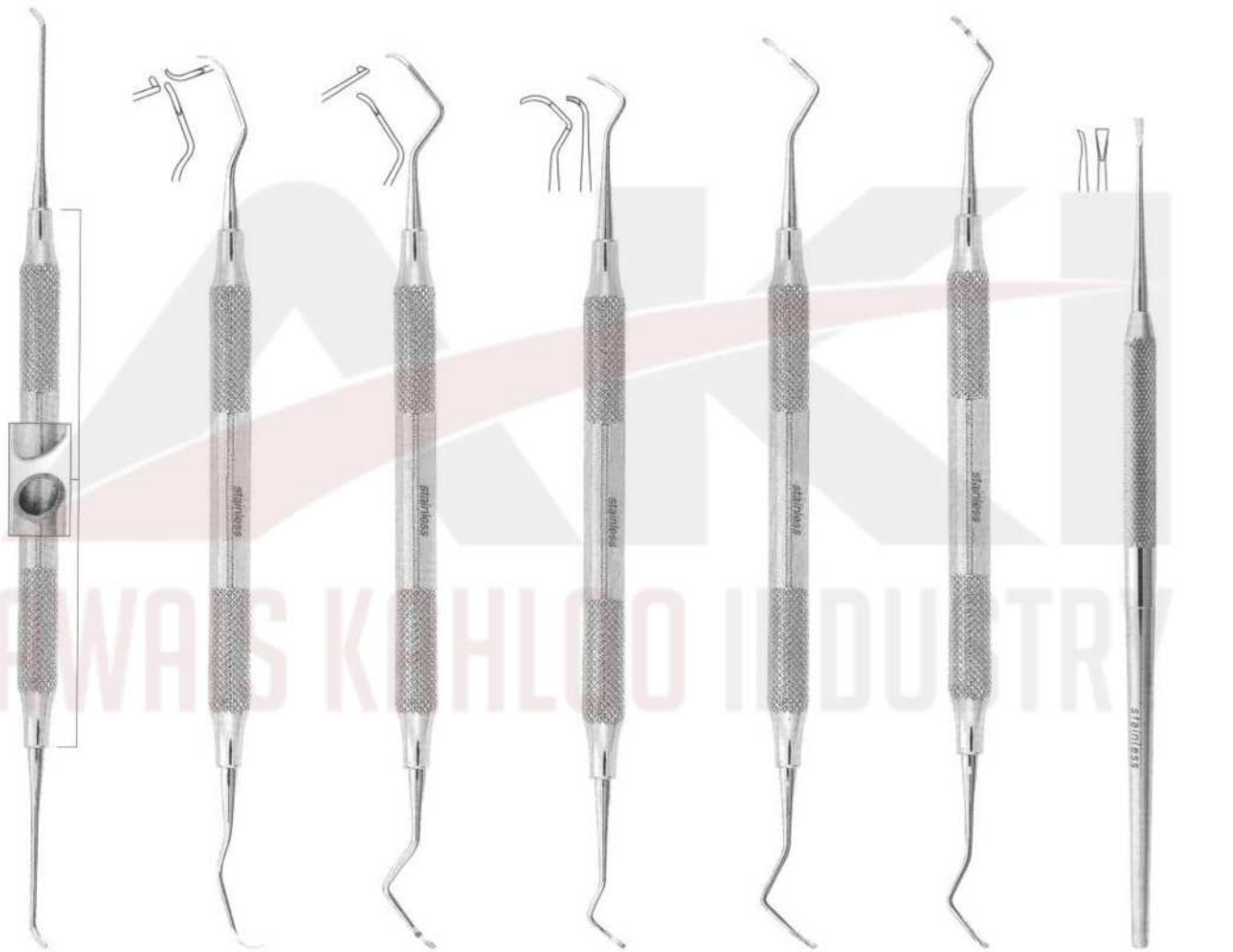

AKI 1540
Curette
Fig. HU 1/2

AKI 1541
Columbia
Fig. 2R/2L

AKI 1542
Columbia
Fig. 4R/4L

AKI 1543
Columbia
Fig. 13/14

AKI 1544
Fig. 413/412

AKI 1545
Fig. 411/414

AKI 1546
Zerfing-chisel

Bone Chisels and Gouges



AKI 1547
Ochsenbein
Fig. 1

AKI 1548
Ochsenbein
Fig. 2

AKI 1549
Gardner
Fig. 1

AKI 1550
Gardner
Fig. 2

AKI 1551
Gardner
Fig. 5

AKI 1552
Gardner
Fig. 5R

AKI 1553
Gardner
Fig. 6

AKI 1554
Wakefield
Fig. 1W

AKI 1555
Wakefield
Fig. 2W

AKI 1556
Buckley
Fig. 3

Bone Chisels and Gouges

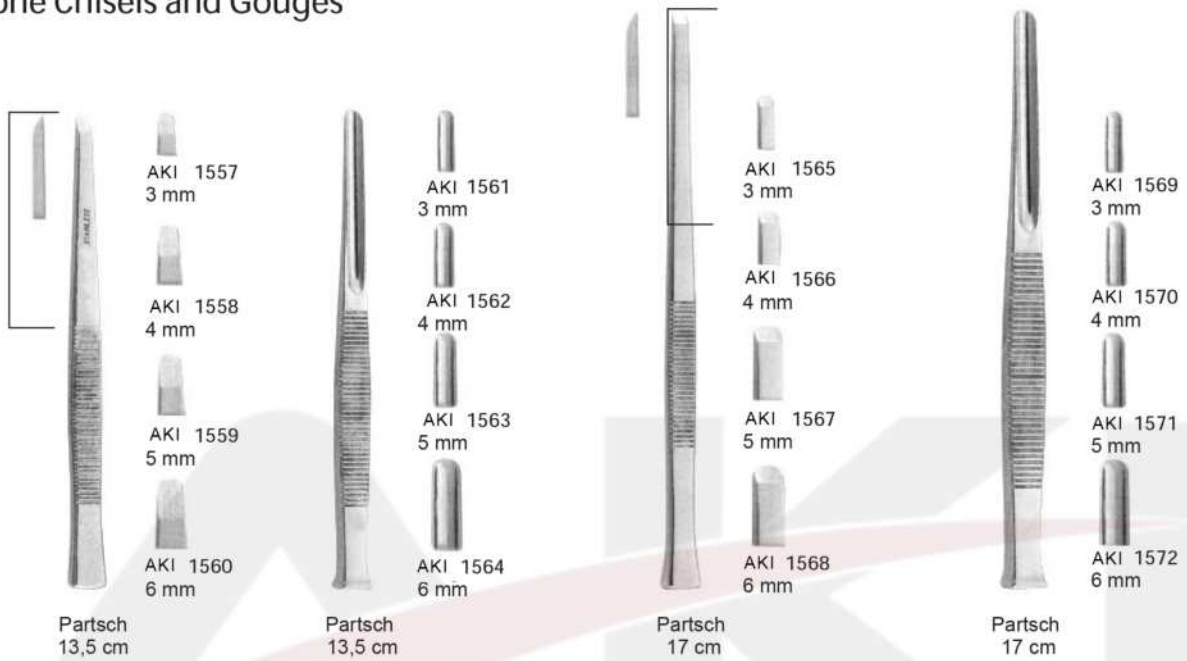

Martelli chirurgici
Mallet



Lead filled

AKI 1573
Partsch
19 cm



Non autoclavable
plastic inserts

AKI 1574
Mead
19,5 cm



With interchangeable
Ferozcel faces

AKI 1575
Mead
17 cm

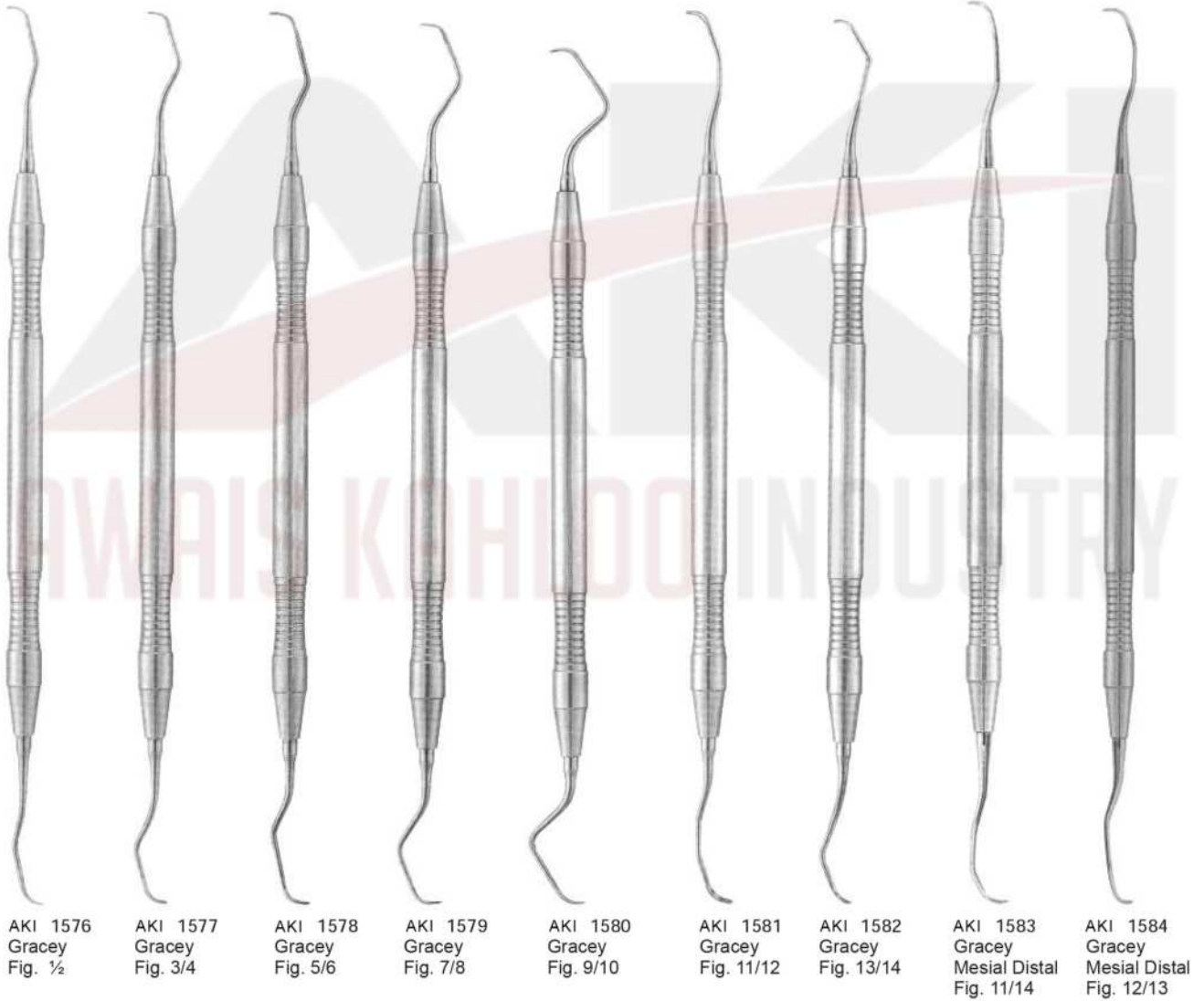
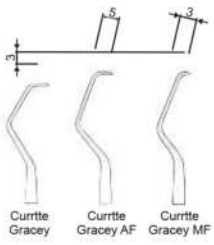

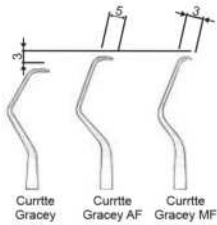

AKI 1585
Gracey
AF/type
Fig. 1/2



AKI 1586
Gracey
AF/type
Fig. 3/4



AKI 1587
Gracey
AF/type
Fig. 5/6



AKI 1588
Gracey
AF/type
Fig. 7/8



AKI 1589
Gracey
AF/type
Fig. 11/12



AKI 1590
Gracey
AF/type
Fig. 13/14



AKI 1591
Gracey
AF/type
Fig. 15/16



AKI 1592
Gracey
AF/type



AKI 1593
Gracey
AF/type
Fig. 1/2



AKI 1594
Gracey
AF/type
Fig. 3/4



AKI 1595
Gracey
AF/type
Fig. 5/6



AKI 1596
Gracey
AF/type
Fig. 7/8



AKI 1597
Gracey
AF/type
Fig. 11/12



AKI 1598
Gracey
AF/type
Fig. 13/14



AKI 1599
Gracey
AF/type
Fig. 15/16



AKI 1600
Gracey
MF/type
Fig. 1/2



AKI 1601
Gracey
MF/type
Fig. 3/4



AKI 1602
Gracey
MF/type
Fig. 5/6



AKI 1603
Gracey
MF/type
Fig. 7/8



AKI 1604
Gracey
MF/type
Fig. 11/12



AKI 1605
Gracey
MF/type
Fig. 13/14



AKI 1606
Gracey
MF/type
Fig. 15/16

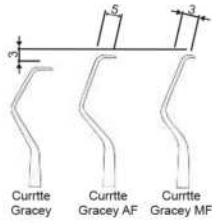

AKI 1607
Gracey
MF/type
Fig. ½

AKI 1608
Gracey
MF/type
Fig. 3/4

AKI 1609
Gracey
MF/type
Fig. 5/6

AKI 1610
Gracey
MF/type
Fig. 7/8

AKI 1611
Gracey
MF/type
Fig. 11/12

AKI 1612
Gracey
MF/type
Fig. 13/14

AKI 1613
Gracey
MF/type
Fig. 15/16

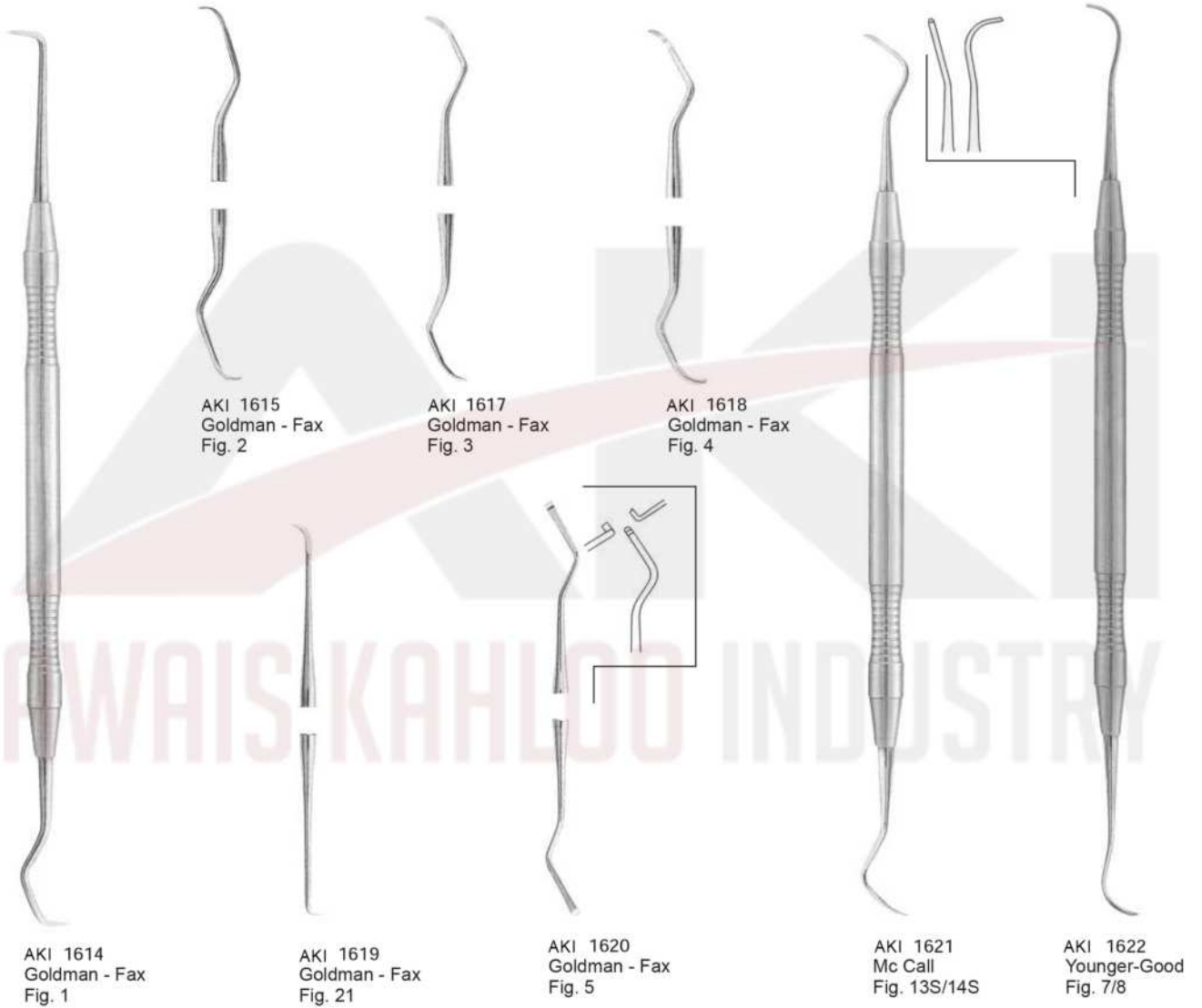

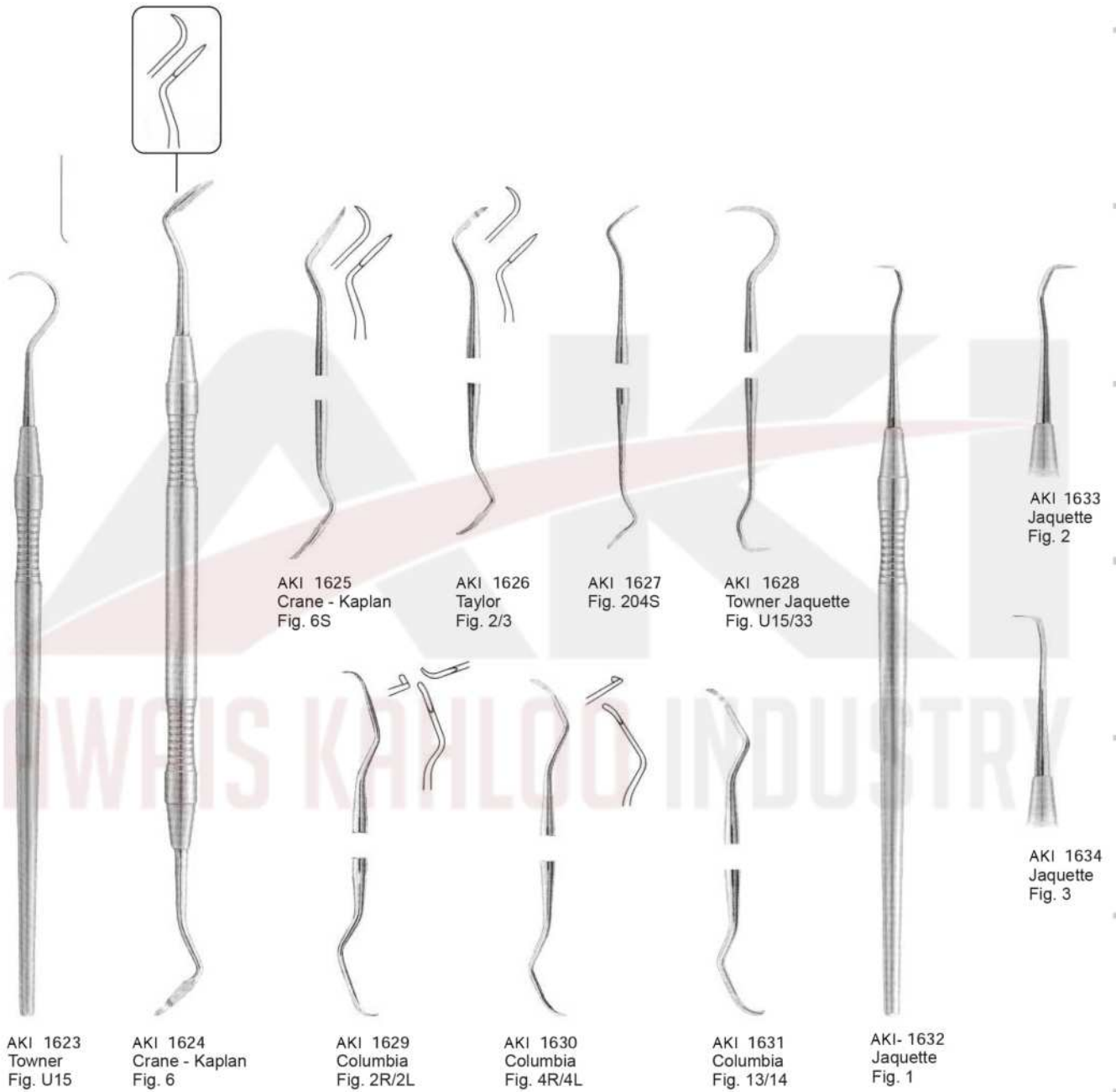



AKI 1635
Hemingway
Fig. 1

AKI 1636
Hemingway
Fig. 2

AKI 1637
Hemingway
Fig. 3

AKI 1638
Lucas
Fig. 85

AKI 1639
Lucas
Fig. 86

AKI 1640
Lucas
Fig. 87



AKI1641 Le Cron AKI 1642 Le Cron AKI 1643 Le Cron AKI 1644 MSY AKI 1645 MSY AKI 1646 Le Cron AKI 1647 Hylin AKI 1648 Hylin AKI 1649 Hylin AKI 1650 Zahle AKI 1651 Zahle AKI 1652 Zahle



AKI 1653 Gritman AKI 1654 Beale AKI 1655 Roach AKI 1656 Verie AKI 1657 P.K. Thomas Fig. 1 AKI 1658 P.K. Thomas Fig. 2 AKI 1659 P.K. Thomas Fig. 3 AKI 1660 P.K. Thomas Fig. 4 AKI 1661 P.K. Thomas Fig. 5



AKI 1662
Boley



AKI 1663
Zuricher
130 mm

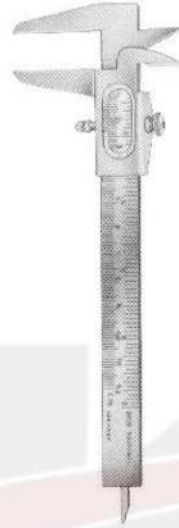

AKI 1664
Vernier
12 cm



AKI 1665
Vernier



AKI 1666
Caroll



AKI 1667
Castroviejo's
Scleral Marker



AKI 1668
Iwanson

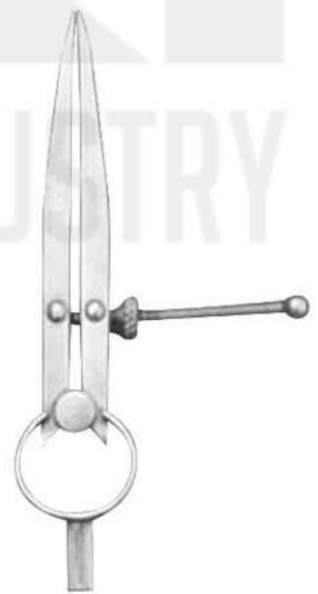

AKI 1669
Albee



MJS-1700
18 cm
7 1/8"



AKI 1701
18 cm
7 1/8"



AKI 1702
17 cm
6 3/4"
Gritman



AKI 1703
17 cm
6 3/4"
Medicon



AKI 1704
22 cm
8 3/4"



AKI 1705
Antkoviak



AKI 1706
Ermert



AKI 1707
Ermert



AKI 1700
18 cm
7 1/8"



AKI 1701
18 cm
7 1/8"

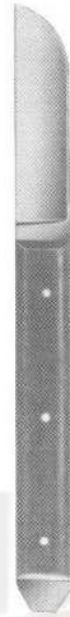

AKI 1702
17 cm
6 3/4"
Gritman



AKI 1703
17 cm
6 3/4"
Medicon



AKI 1704
22 cm
8 3/4"



AKI 1705
Antkoviak



AKI 1706
Ermert



AKI 1707
Ermert



AKI 1708
Fahnenstock
Fig. 1
12,5cm

AKI 1709
Fahnenstock
Fig. 2
17cm

AKI 1710
Lessmann
Fig. 1
12,5cm

AKI 1711
Lessmann
Fig. 2
17cm

AKI 1712
Con scodellino
Fig. 1
12,5cm

AKI 1713
Con scodellino
Fig. 2
17cm



AKI 1714
Fig, 1
17 cm



AKI 1715
Gritman
Fig, 2
17 cm



AKI 1716
Fig, 3
16 cm



AKI 1717
Fig, 4
16 cm

Explorers



AKI 1800
Fig 23

AKI 1801
Fig 6

AKI 1802
Fig 8

AKI 1803
Fig 9

AKI 1804
Fig 17

AKI 1805
Fig 3
Rein

AKI 1806
Fig 23/17

AKI 1807
Fig 17



AKI 1808
Fig.1
Spreader

AKI 1809
Fig.2
Spreader

AKI 1810
Fig.3
Spreader

AKI 1811
Fig.4
Spreader

AKI 1812
Fig.5
Spreader

AKI 1813
Fig.6
Spreader

AKI 1814
Fig.7
Spreader

Double-Ended Root Canal
Explorers Plugger/Spreaders

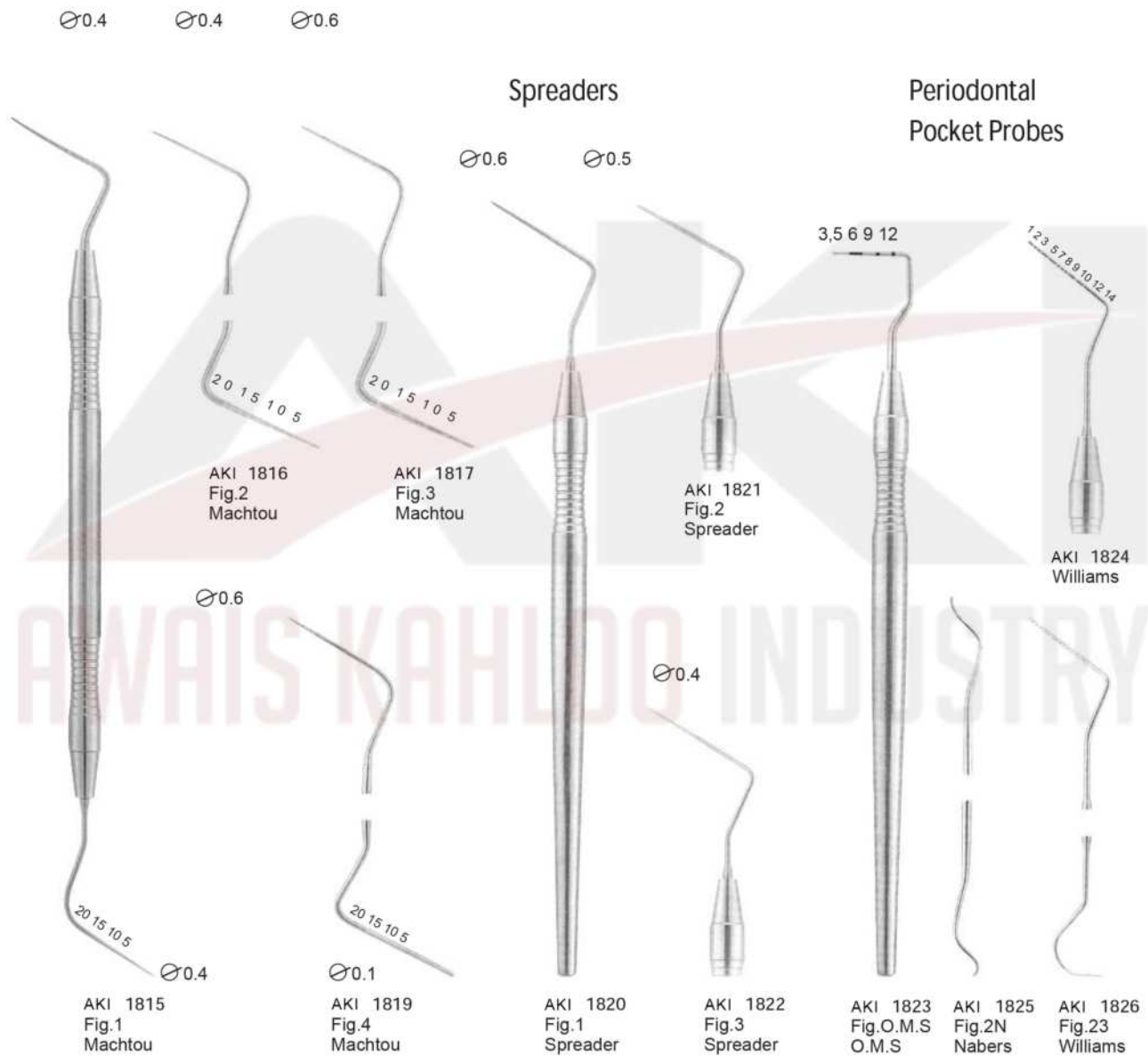

Root-canal pluggers

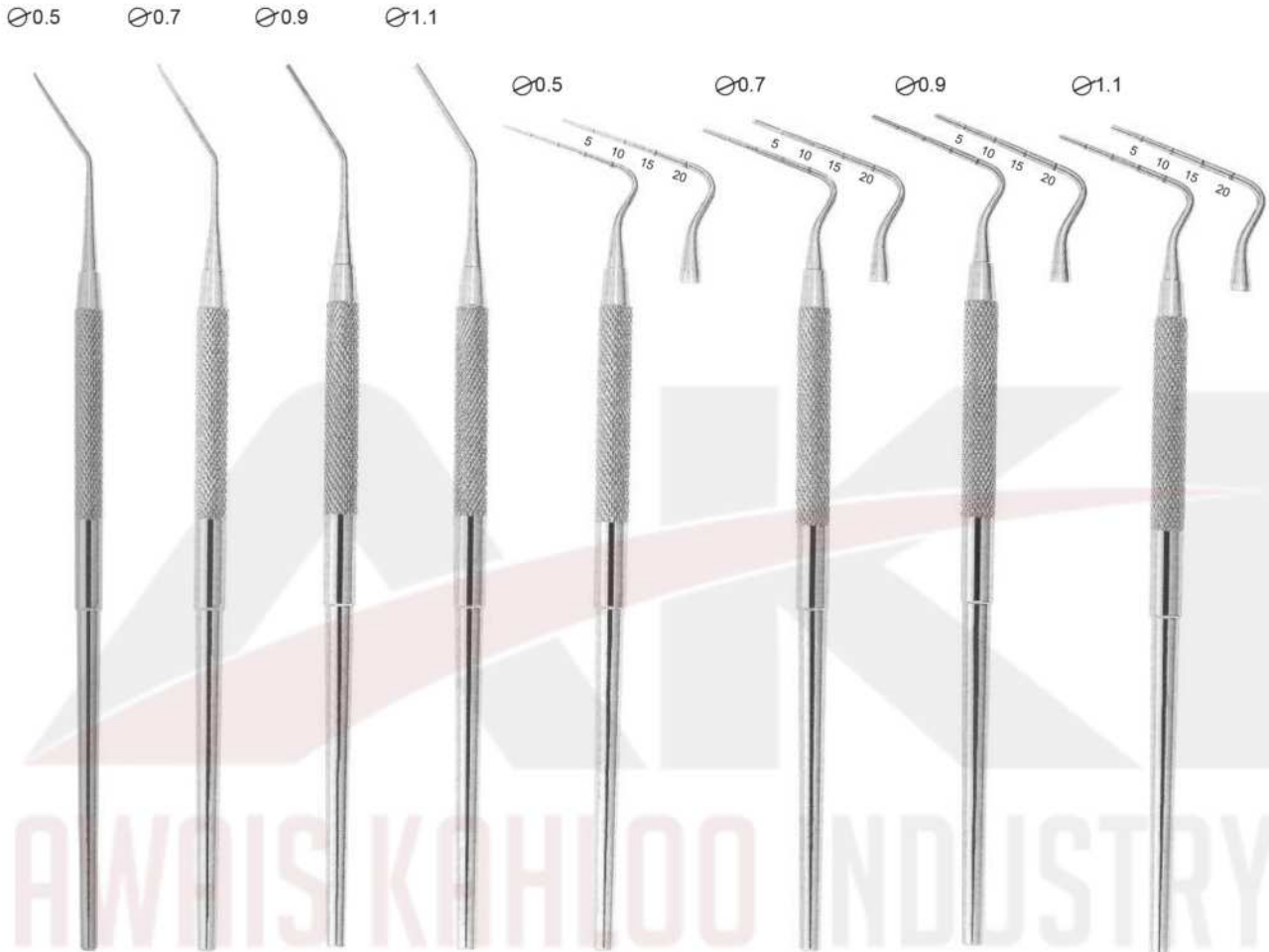

AKI 1827
Fig.1
Luks

AKI 1828
Fig.2
Luks

AKI 1829
Fig.3
Luks

AKI 1830
Fig.4
Luks

AKI 1831
Fig.1
Vertical
condenser

AKI 1832
Fig.2
Vertical
condenser

AKI 1833
Fig.3
Vertical
condenser

AKI 1834
Fig.4
Vertical
condenser

Endodontic set



1835
Measuring Plate

Root-canal pluggers

Optimum Flexibility
Very Fine Points

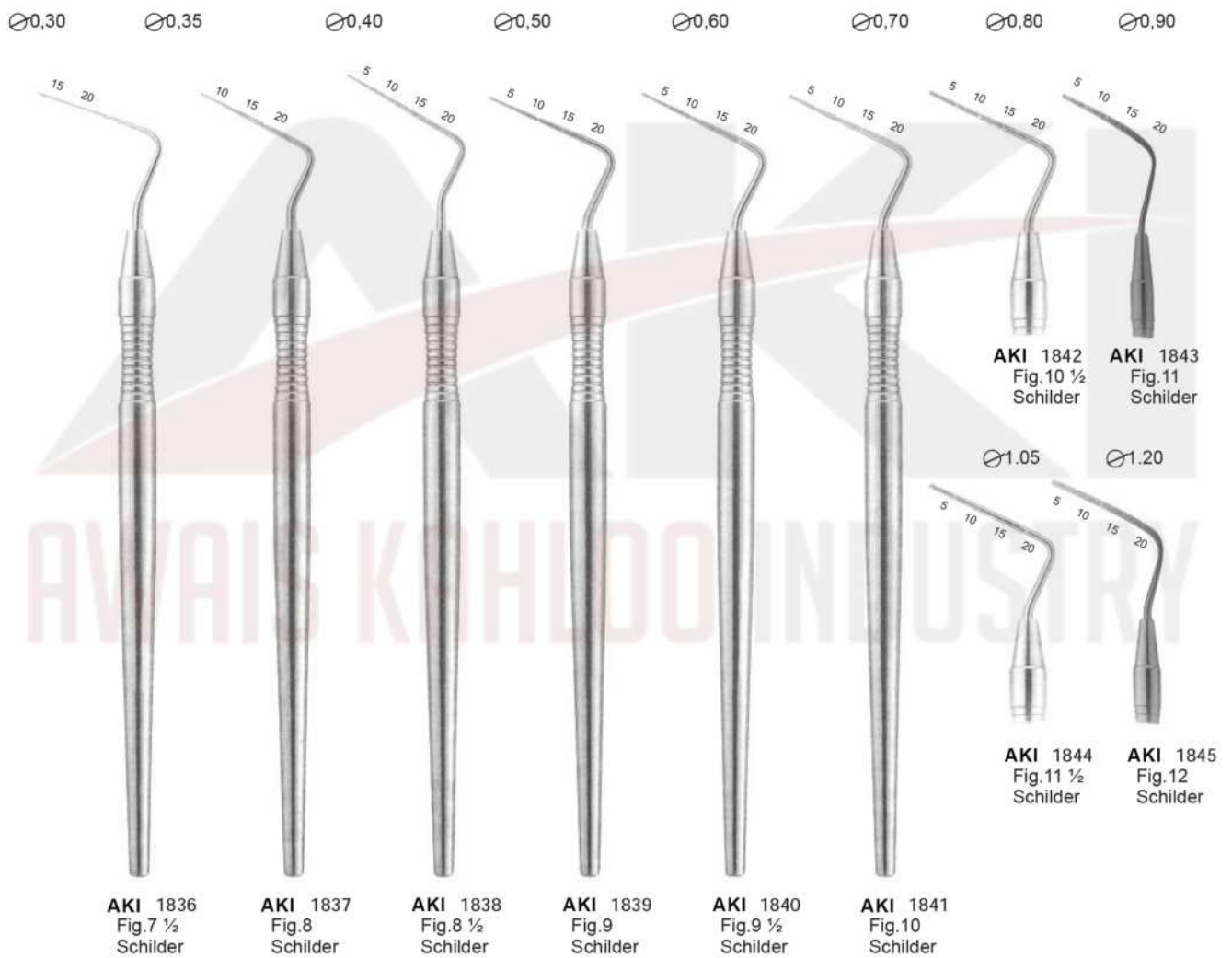

Root-canal explorers

Root-canal excavators



AKI 1846
Fig.6/1

AKI 1847
Fig.6/17

AKI 1848
Fig.6/23



AKI 1849
Fig.31L

AKI 1850
Fig.32L

AKI 1851
Fig.33L

1 mm



AKI 1852
Fig 5

1.2 mm



AKI 1853
Fig 14

1 mm



AKI 1854
Fig 17

1.2 mm



AKI 1855
Fig 18

1.6 mm



AKI 1856
Fig 19

2 mm



AKI 1857
Fig 20

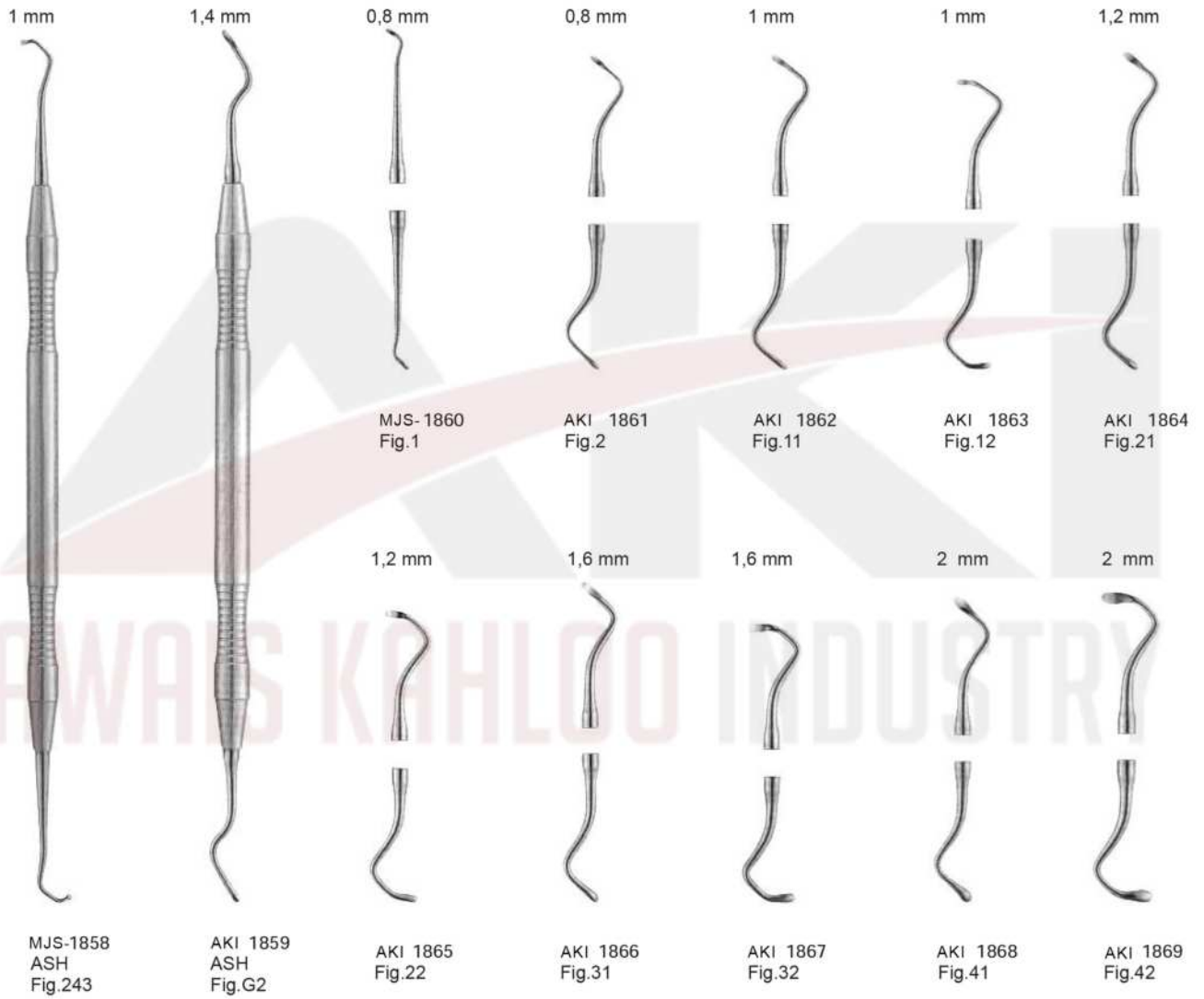





AKI 1911



AKI 1912



AKI 1913



AKI 1914



AKI 1915



AKI 1916
Parallelometer
mouth mirror

AKI 1917
Parallelometer
mouth mirror
+ handle
code 2101



With cone - socket

Plane

Magnifying



AKI 1918
Fig.5
Ø24 mm



AKI 1919
Fig.4
Ø22 mm



AKI 1920
Fig.5
Ø24 mm



AKI 1921
Fig.4
Ø22 mm



AKI 1922
Cone - socket



AKI 1923
Cone - socket



AKI 1924
Cone - socket

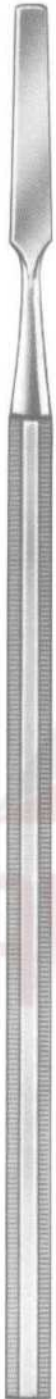

2000

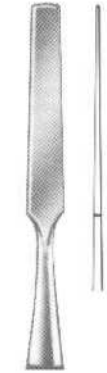

AKI 2001



AKI 2002



AKI 2003



2004

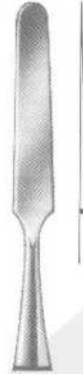

AKI 2005



AKI 2006



AKI 2007

AWAIS KAHLOO INDUSTRY



2008



2009



AKI 2010



AKI 2011



AKI 2012



AKI 2013

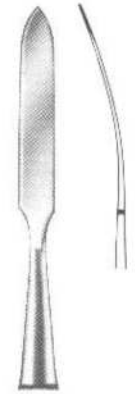

AKI 2014

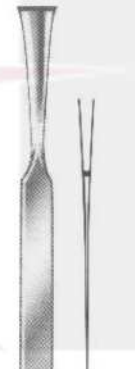







AKI 2200
Mayo-Hegar
16 cm

AKI 2201
Mayo-Hegar TC
16 cm

AKI 2202
Mayo-Hegar
18 cm

AKI 2203
Mayo-Hegar TC
18 cm



AKI 2204
Mini-Ryder
18 cm

AKI 2205
Mini-Ryder
15 cm

AKI 2206
Derf
12 cm

AKI 2207
Hegar-Baumgarther
14 cm



AKI 2208
Crile-Wood
15 cm



AKI 2209
Crile-Wood TC
15 cm



AKI 2210
Adson
17.5 cm



AKI 2211
Olsen-Hegar
14 cm



AKI 2212
Baumgarther
14.5 cm



AKI 2213
Gillies
16 cm



AKI 2214
Gillies
16 cm



AKI 2215
Hegar-Baumgarther
14 cm



AKI 2216
Toennis
18 cm



AKI 2217
Toennis
18 cm



AKI 2218
Lichtenberg
17 cm



AKI 2219
Lichtenberg
17 cm



AKI 2220
Eiselberg-Mathieu
19.5 cm



AKI 2221
Boynton
12 cm



AKI 2222
Arruga
16 cm



AKI 2223
Boynton
12 cm



AKI 2224
Arruga
16 cm



MJS-2225
Castroviejo
14 cm



MJS-2226
Castroviejo
14 cm



AKI 2227
Castroviejo
14/60 cm



AKI 2228
Castroviejo
18 cm



AKI 2229
Castroviejo
18 cm



AKI 2230
Castroviejo
14 cm



AKI 2231
Castroviejo
14 cm



AKI 2232
Castroviejo
14/60 cm



AKI 2233
Castroviejo
18 cm



AKI 2234
Castroviejo
18 cm



AKI 2235
Mathieu
14 cm



AKI 2236
Mathieu
14 cm



AKI 2237
Mathieu
14 cm



AKI 2238
Mathieu
14 cm



AKI 2239
Mathieu
17 cm



AKI 2240
Mathieu
17 cm



AKI 2241
Mathieu
14 cm



AKI 2242
Micro-Barraquer
18 cm



The tips have tungsten carbide inserts for better handling.



AKI 2243
Mathieu
17 cm



AKI 2244
Mathieu
17 cm



AKI 2245
Micro-Barraquer
14 cm



AKI 2246
Castroviejo
13 cm



AKI 2247
Castroviejo-Barraquer
13 cm



AKI 2248
Castroviejo
13 cm



AKI 2249
Castroviejo
13 cm



AKI 2251
18.03mm,cm



AKI 2252
18.04mm,cm



AKI 2253
18.05mm,cm



2254
Fig.12FR
Fraizer
15.04mm,cm



2255
Fig.10FR
Fraizer
15.03,3mm,cm



2256
Fig.8FR
Fraizer
15.02,7mm,cm



AKI 2250
Fig.6FR
Fraizer
15.02mm,cm



AKI 2300
Water Syringe complete with
1 cannula (Lure-Lock)



AKI 2301
Water Syringe complete with
1 cannula (Lure-Lock)



AKI 2302
Metal water syringe, self-filling,
with 1 cannula (Lure-Lock)



AKI 2303
Sparrel Barrel with
plunger suitable for
syringes



AKI 2304
Cannula, only, with
Luer-Lock connector
suitable for syringes

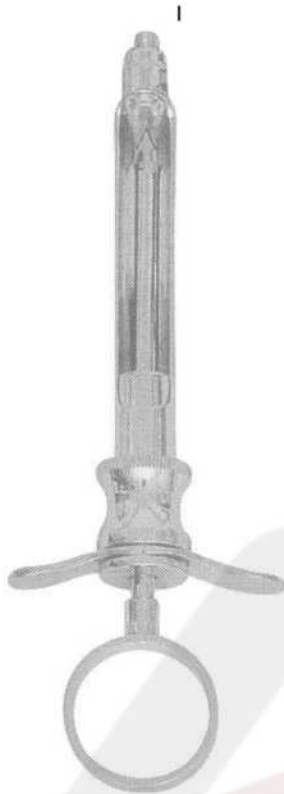

AKI 2305
Aspirating Syringe



AKI 2306
Position Gauge

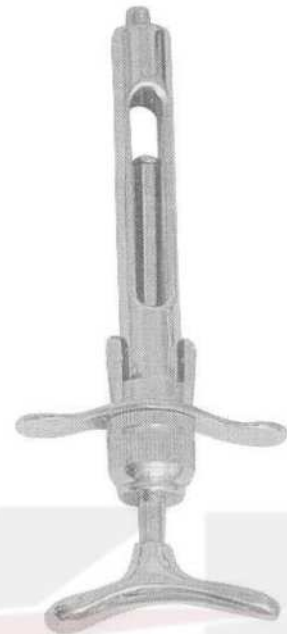

AKI 2307
Breech Loading Syringe



AKI 2308
Aspirating & Breech Syringe



AKI2309
Band Adaptor



AKI 2310
Endo Finger Ruler
With Adjustable Slide



AKI 2311
Aspirating Syringe



AKI 2312



AKI 2314



AKI 2313

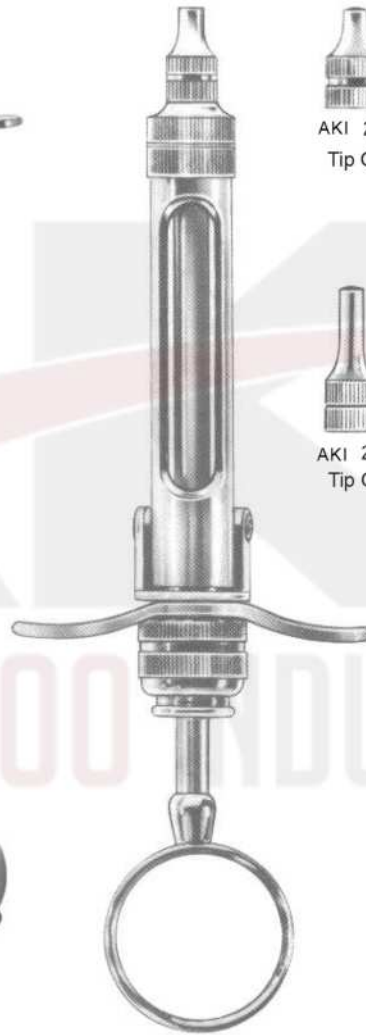

AKI 2315 1,8 ml
AKI 2316 2,2 ml

Cartridge Syringe complete
With 2 tips and without needles



AKI 2317
Tip Only, short



AKI 2318
Tip Only, long



AKI 2319



2320



2321



AKI 2322
Cork screw tip



AKI 2323
Cork screw tip



AKI 2324
Folding type, cork
screw tip



AKI 2325
Folding type, cork
screw tip



AKI 2326



2330
Autoclavable Plastic Protection sleeve



AKI 2327
Cork screw tip



AKI 2328
Spare cap with
metric thread



AKI 2329
With Whitworth
thread



AKI 2331
Brass syringe with stainless steel moving parts



AKI 2332
Brass syringe with stainless
steel moving parts

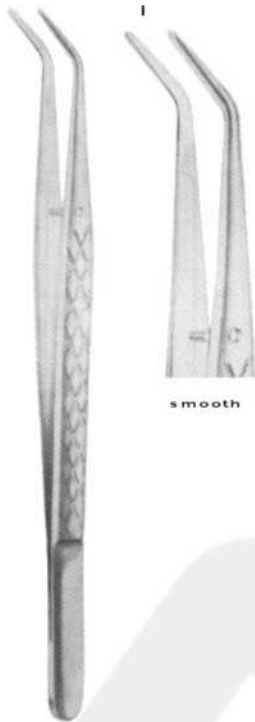

smooth

AKI 2400
College
15 cm

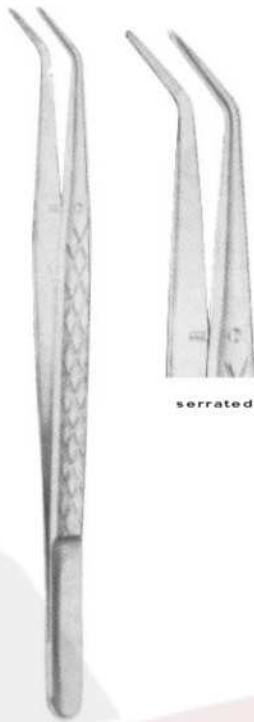

serrated

AKI 2401
College
15 cm

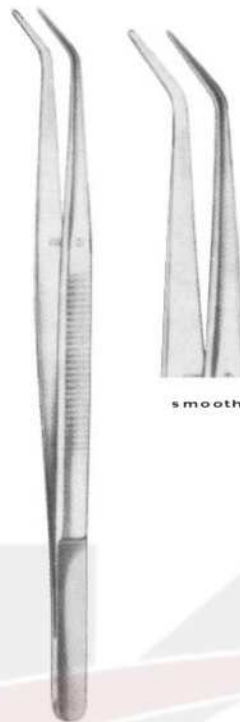

smooth

AKI 2402
College
15 cm

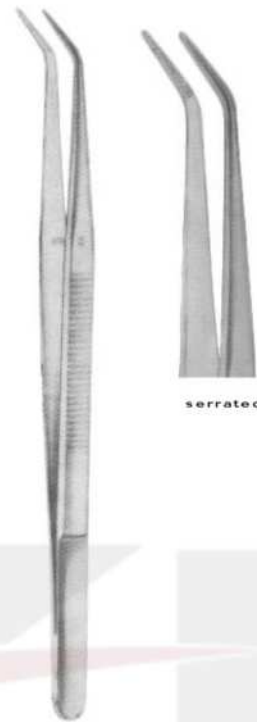

serrated

AKI 2403
College
15 cm



smooth

AKI 2404
College
15 cm

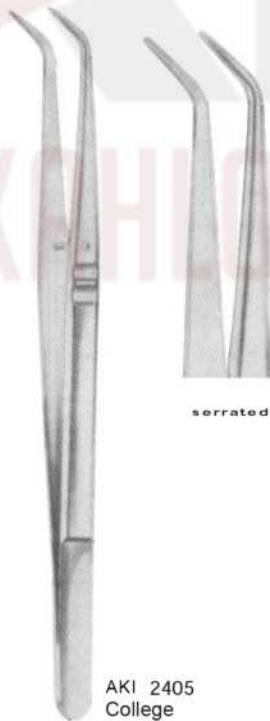

serrated

AKI 2405
College
15 cm



smooth

AKI 2406
College
15 cm



serrated

AKI 2407
College
15cm

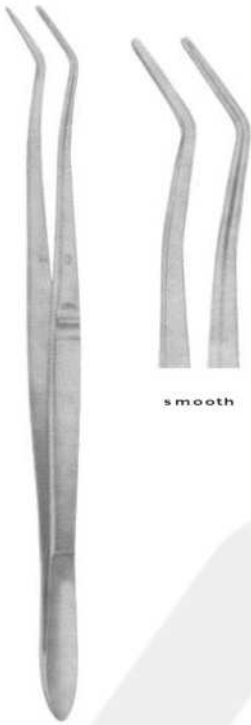

smooth

AKI 2408
Meriam
16 cm

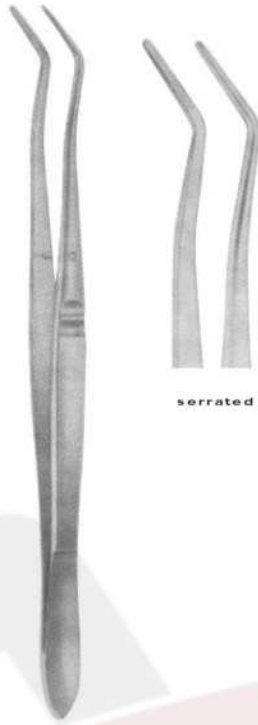

serrated

AKI 2409
Meriam
16 cm

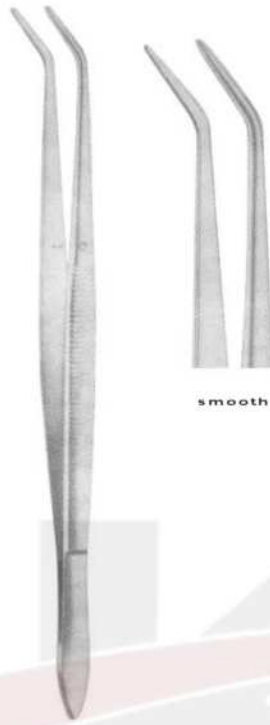

smooth

AKI 2410
Meriam
16 cm

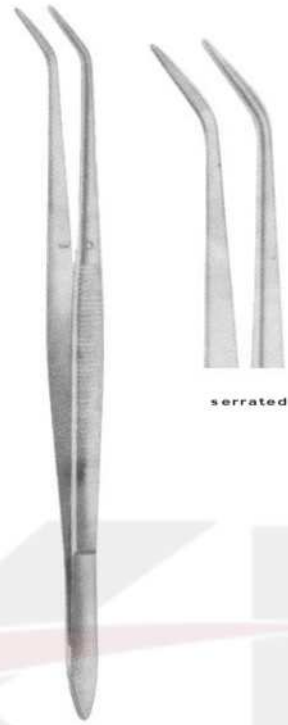

serrated

AKI 2411
Meriam
16 cm



smooth

AKI 2412
Meriam
16 cm



serrated

AKI 2413
Meriam
16 cm

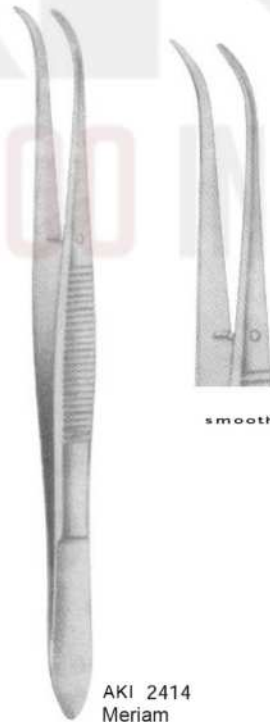

smooth

AKI 2414
Meriam
16 cm

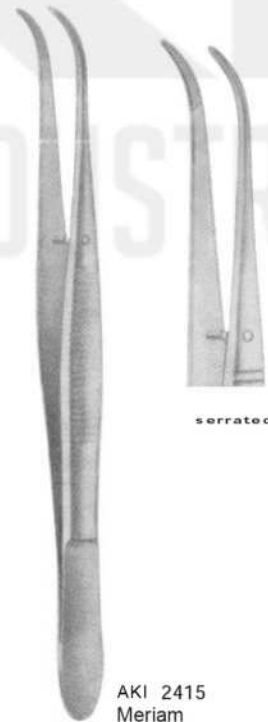

serrated

AKI 2415
Meriam
16 cm
15cm



AKI 2416
College
14.5 cm, 5³/₄"

AKI 2417
Flagg
16 cm, 6¹/₄"

AKI 2418
Flagg
16 cm, 6¹/₄"

AKI 2419
Landgraf
15 cm, 6"

AKI 2420
15,5 cm, 6¹/₈"



AKI 2421
15.5 cm, 6¹/₈"

AKI 2422
London-College
15 cm, 6"

AKI 2423
London-College
15 cm, 6"

AKI 2424
London-College
15 cm, 6"

AKI 2425
London-College
15 cm, 6"



AKI 2426
CK1
15 cm, 6"

AKI 2427
CK2
15 cm, 6"

AKI 2428
GF2
16 cm, 6 1/4"

AKI 2429
Gf1
16 cm, 6 1/4"

AKI 2430
Kopp
15.5 cm, 6 1/8"



AKI 2431
Kopp
15.5 cm, 6 1/8"

AKI 2432
15 cm, 6"

AKI 2433
16.5 cm, 6 1/2"

AKI 2434
15.5 cm, 6 1/8"

AKI 2435
15.5 cm, 6 1/8"



AKI 2436
London-College
15 cm, 6"



AKI 2437
London-College
15 cm, 6"

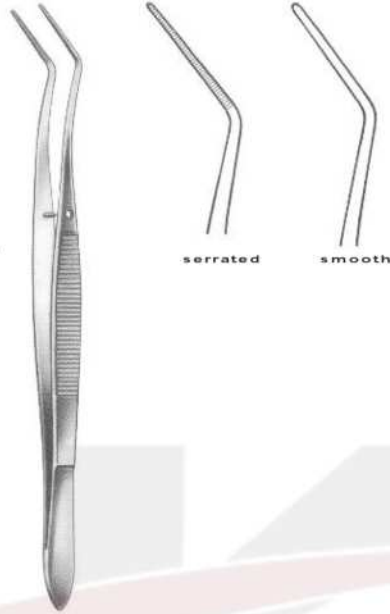

AKI 2438
Meriam
16 cm, 6 1/4"

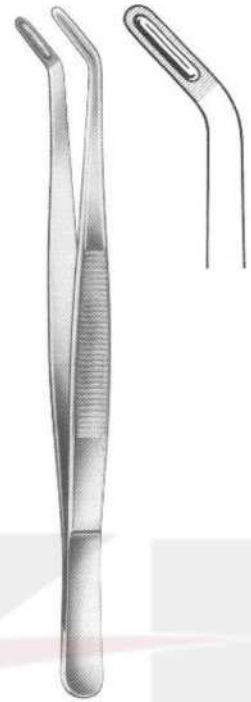

AKI 2439
Allen
18 cm, 7 1/8"



AKI 2440
Albrecht
16 cm, 6 1/4"



AKI 2441
Albrecht
16 cm, 6 1/4"



AKI 2442
16 cm, 6 1/4"



AKI 2443
16 cm, 6 1/4"



AKI 2444
16 cm, 6 1/4"

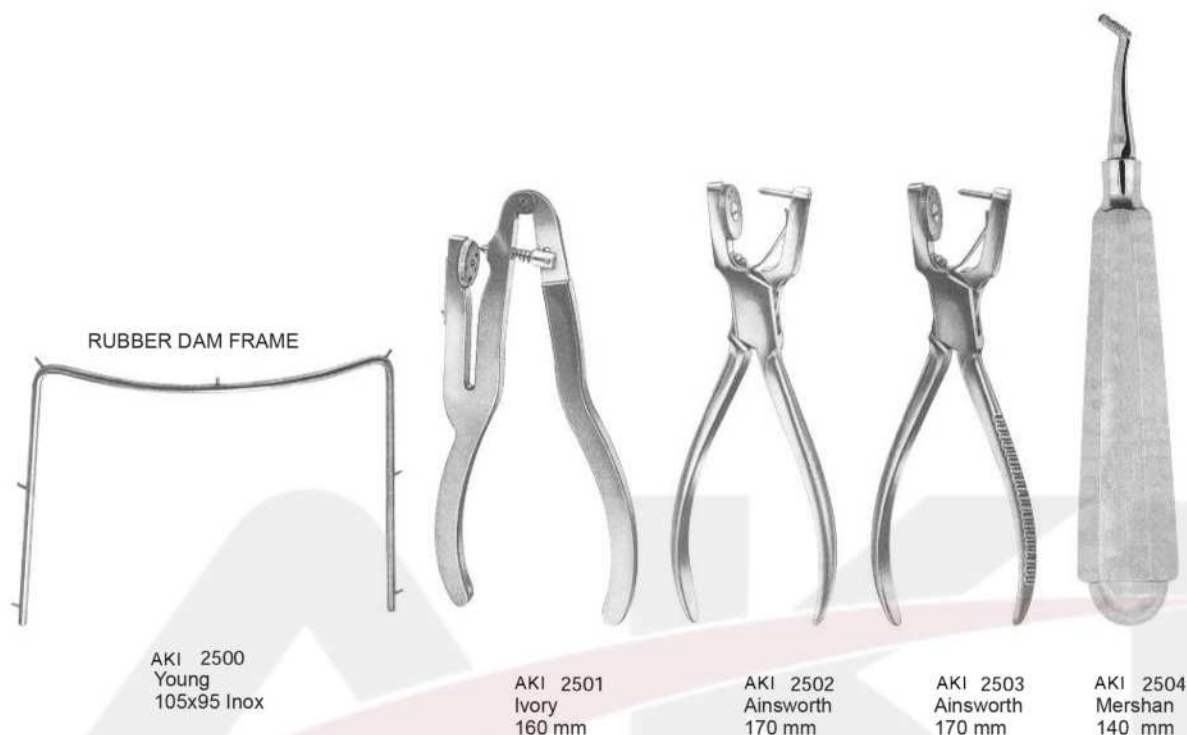

CLAMPS (PLIERS)





2600
Ivory
63mm



AKI 2601-1
Tofflemire-Universal



AKI 2602-2
Tofflemire-Junior



AKI 2603-3
Tofflemire-Senior



AKI 2604-5
Ivory 8
5 mm



AKI 2605-6
Ivory 6
6 mm



AKI 2606
Ivory 8
7 mm



AKI 2607
Ivory 8 N



AKI 2608
Didner 8 P



AKI 2610-7

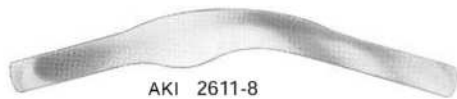

AKI 2611-8



AKI 2612-9

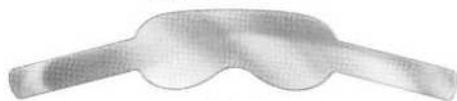

AKI 2613-10

1750-5 mm x 100 cm
1750-6 mm x 100 cm
1750-7 mm x 100 cm



2609

For Molars and Premolars



AKI 2614-11



AKI 2615-12



AKI 2616-13



AKI 2617
Molar
Fig 7



AKI 2618
Molar
Fig 8



AKI 2619
Molar
Fig 9



AKI 2620
Molar
Fig 10



AKI 2621
Toffemire



AKI 2622
Toffemire



AKI 2623
Toffemire

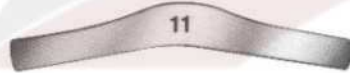

AKI 2624
Bicuspid



AKI 2625
Bicuspid



AKI 2626
Bicuspid



AKI 2627
Bicuspid



AKI 2628
Bicuspid



AKI 2629
Bicuspid



AKI 2633



AKI 2630
Molar



AKI 2631
Molar



AKI 2632
Molars

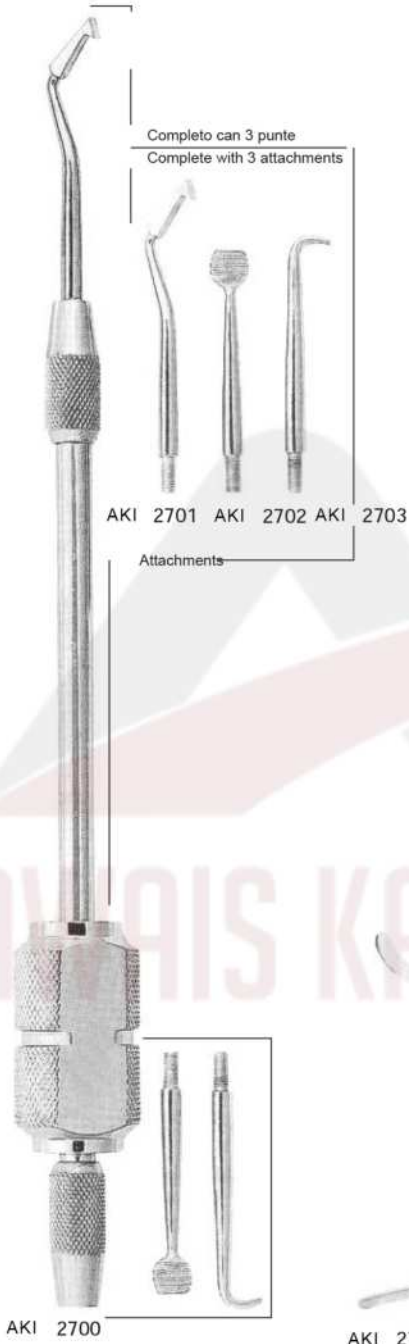

AKI 2704
Crown Spreader, Crown Remove.
Special instrument for crown spreading
after separating, simple and safe
operation.





Universal "HM"
12 cm, 4 3/4"



AKI 2709



AKI 2710



AKI 2711
Beebee
10,5 cm, 4 1/8"



AKI 2712
Mershon



AKI 2713
Morell



AKI 2714
Morell



AKI 2715
Morell



AKI 2716
Morell



AKI 2717
Treymann



AKI 2718
Automatic Crown Remover
With 2 Points



AKI 2719



AKI 2720

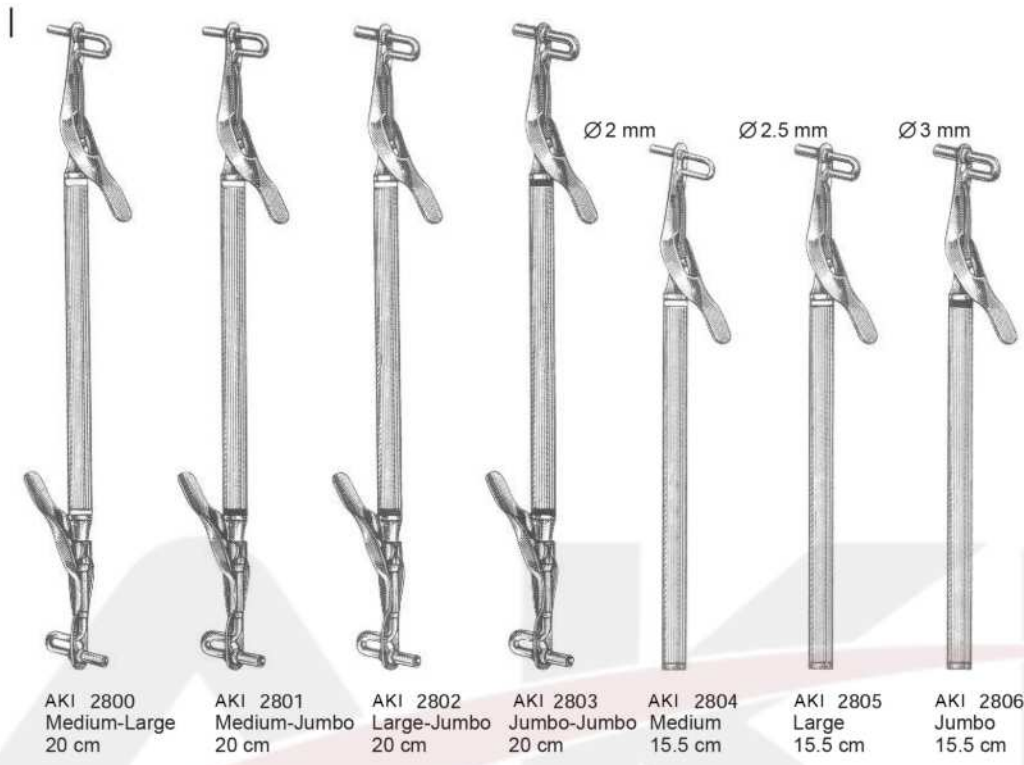

AKI 2810
Amalgam Well
Non Skid Base
Ø 3.5 mm

Copper ring removing pliers



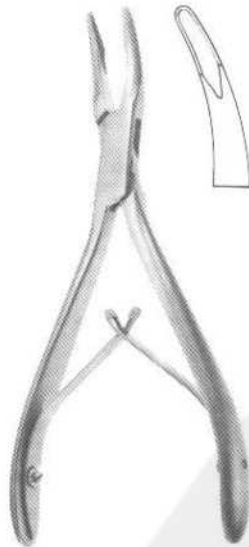

AKI 3000
Friedmann
14 cm, 5 1/2"

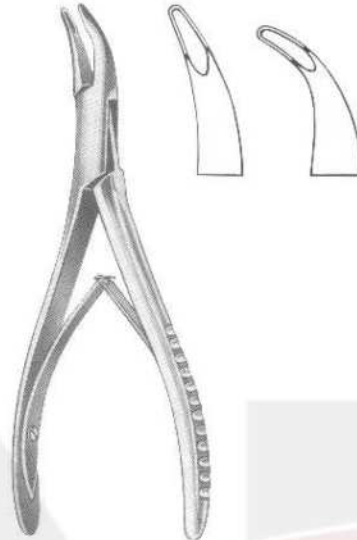

AKI 3001
14 cm, 5 1/2"

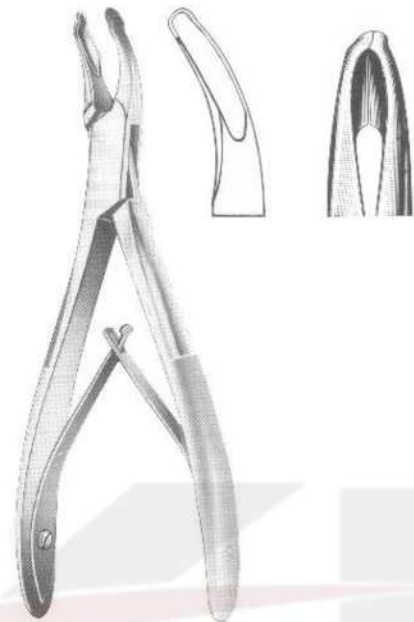

AKI 3002
Mead
14 cm, 5 1/2"



AKI 3003
Mead
14 cm, 5 1/2"



AKI 3004
Mead
17 cm, 6 3/4"



AKI 3005
Schell
17 cm, 6 3/4"



AKI 3006
Luer
15 cm



AKI 3007
Friedman
14 cm



AKI 3008
Mini Friedman
12 cm



AKI 3009
Goldman-Fax
10 cm



AKI 3010
Blumenthal
15 cm



AKI 3011
Blumenthal 45
14,5 cm



AKI 3012
Blumenthal 90
14 cm



AKI 3013
Bohler
15 cm



AKI 3014
Kerrison
15 cm



AKI 3015
Blumenthal
16 cm, 6 1/4"



AKI 3016
Blumenthal
16 cm, 6 1/4"



AKI 3017
Blumenthal
16 cm, 6 1/4"

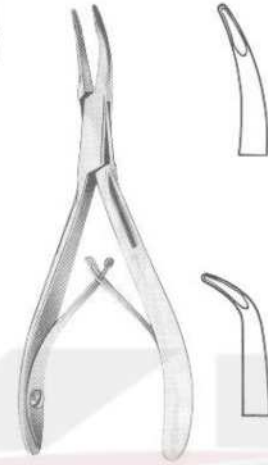

AKI 3018
Kleinert-Kutz
14 cm, 5 1/2"



AKI 3019
Ruskin-Mini
15 cm



3 mm



AKI 3020
Beyer
18 cm, 7 1/8" AKI



AKI 3021
Zaufal-Jansen
18 cm, 7 1/8"

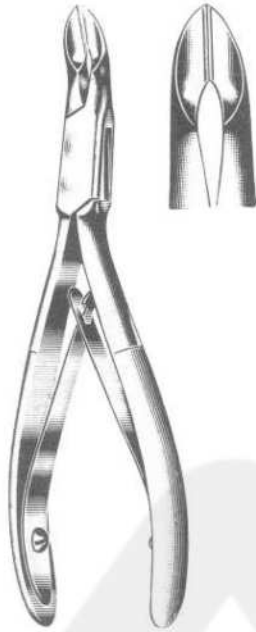

AKI 3022
Niro
No. 5 S, 14 cm, 5 1/2"



AKI 3023
Cleveland
No. 5 S, 17 cm, 6 3/4"



AKI 3024
No. 18, 15 cm, 6"



AKI 3025
Cleveland
16 cm, 6 1/4"



AKI 3026
Gardner
16 cm, 6 1/4"



AKI 3027
Liston-mini
15 cm, 6"



AKI 3100
Williger
16 cm, 6 1/4"

AKI 3101
Henahan
17 cm, 6 3/4"



AKI 3102
Freer
19 cm, 7 1/2"

AKI 3103
Bennet
17 cm, 6 3/4"

AKI 3104
Seldin
19 cm, 7 1/2"

AKI 3105
Seldin
19,5 cm, 7 3/4"

Pinze per formare loops
Loops forming pliers



AKI 3200
Adams
Adams pliers for bending
wires up to 0,7mm. (.28").



AKI 3201
Adams
Adams pliers for bending
wires up to 0,7mm. (.28").

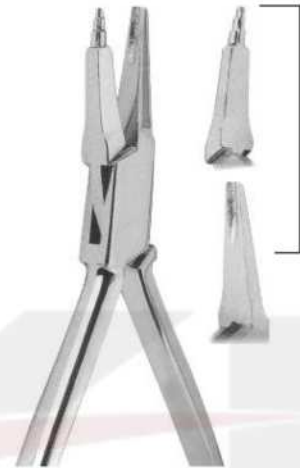

AKI 3202
Adams
Tweed loop forming pliers.
For forming loop in wires up
to 0,56 mm. (.22").



AKI 3203
Adams
Aderer three jaws bending
pliers. For wires up
to 0,7 mm. (.28").



AKI 3204
Adams
Aderer three jaws bending
pliers. For wires upto 0,7 mm.
(.28").

Ligature Cutter Pliers



AKI 3205

Micro-miniature light wire cutter. It cuts soft ligature wires. For use in caso of limited access. Caution: maximum cutting capacity: soft ligature wire up to 0,30 mm. (.012").



AKI 3206

Wire cutter. For ligature wires and pins. It is strong enough to bend archwire ends after distal cutting. Maximum cutting capacity up to 0,56 x 0,7 mm. (.022" x .028").

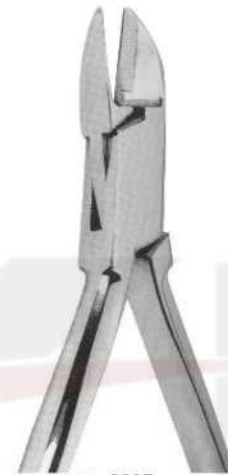

AKI 3207

Wire cutter. For ligature wires and pins. It is strong enough to bend archwire ends after distal cutting. Maximum cutting capacity: up to 0,9 mm. (.036").

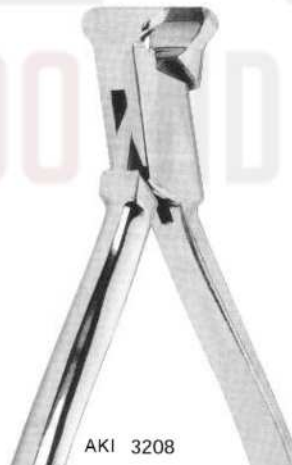

AKI 3208

Wire cutter. For ligature wires and pins. It is strong enough to bend archwire ends after distal cutting. Maximum cutting capacity: up to 1,5 mm. (.044").

Pinze per formare laboratorio
Laboratory pliers



AKI 3209

Flat nose pliers with smooth beaks for bending wires up to 0,7 mm. (.028").



AKI 3210

Bending wires up to 0,7 mm. (.028").



AKI 3211

Bending wires up to 0,7 mm. (.028").



AKI 3212

Bending wires up to 0,7 mm. (.028").



AKI 3213
Nance

Nance loop closing pliers, for bending of stop loops and special for Adams' clasps. Wires up to 0,7 mm. (.028").



AKI 3214
Nance

Universal pliers for bending wires up to 0,9 mm. (.035") or cutting up to 0,7 mm. (.028").

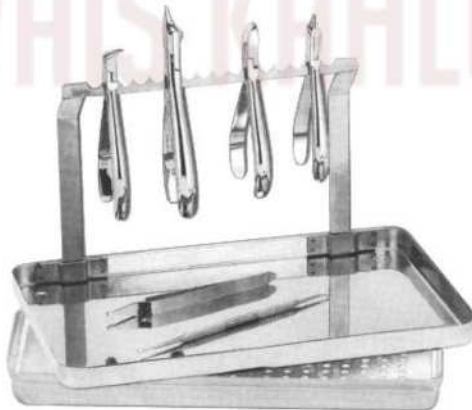

AKI 3215

Stainless steel pliers tray standard dimensions



AKI 3216
Universal

Universal pin roughening, cutting and bending pliers. For wires up to 0,9 mm. (.035"). Will cut wires up to 0,7 mm. (.028").

Utility and specialty pliers



AKI 3217
Reynolds
Reynolds contouring pliers.



AKI 3218
Reynolds

Lingual arch pliers used to form double and triple back bends in 0,7 mm (.028") or 0,9 mm (.035") wire for insertion in lingual sheaths.



AKI 3219
Weingart

Weingart pliers with serrated points.



AKI 3220
De La Rosa

De La Rosa arch forming pliers. Designed to form and contour arch wires on round or rectangular wire. The beak has grooves of 0,4 mm (.016"), 0,46 mm (.018") and 0,56 mm (.022").



AKI 3221
De La Rosa

Arch forming pliers with a non grooved contouring surface the forming of precise arches.

Loop formare pliers



AKI 3222
Waldsachs

Waldsachs universal pliers for bending wires up to 1,0 mm. (.039") or cutting up to 0,7 mm. (.028").



AKI 3223

Round and Concave pliers for loop forming and bending of thin round and square wires up to 0,5 mm. (.020").



AKI 3225
Tweed

Tweed Loop Forming Pliers. For making perfect Omega Loops with round or rectangular wires up to 0,56 x 0,7 mm. (.022" x .028"). The concave beak is exactly the same as pliers 5809-1



AKI 3224
Tweed

Tweed loop Forming Pliers. For round or rectangular wires up to 0,56 x 0,7 mm. (.022" x .028"). Replaceable cylindrical beak with three sizes: 1,15 mm. (.045), 1,50 mm. (.059"), 1,90 mm. (.075"). Concave beak with slight parallel serrations, to keep the wire in proper position.



AKI 3226
Tweed

Single diameter loop forming pliers. Wire up to 0,56 x 0,7 mm. (.022" x 0,28"). Replaceable concave beak has only one diameter section of 1,50 mm. (.059").

Distal end cutters

D.B. bracket remover pliers



AKI 3227

Distal end cutter -safety hold- a precision cutter designed for distal arch cutting in the patient's mouth. It cuts hard wires end holds the loose distal end preventing any damaging of oral tissue. Maximum cutting capacity rectangular wires up to 0,56 x 0,7 mm. (.022" x .020").



AKI 3228
Micro-distal end cutter - safety hold-. Similar to 3227



AKI 3229
Direct bonding bracket remover (wide). The removal grip firmly for easy incisal-gingival (vertical) use or, if needed, for mesial-distal (horizontal) use with the same ease.

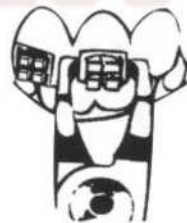

AKI 3230

Direct bond attachment remover (angled). For removing all bonded attachments. May be used mesial-distal-horizontal) or incisal-gingival (vertical) in anterior areas. Angled perfectly for easy access to difficult posterior areas.

Bird beak pliers



AKI 3231
Wire bending pliers. For wires up to 0,9 mm. (.036").



AKI 3232
Bird Beak Angle pliers for bending round, square or rectangular wire up to 0,7 mm. (.028").



AKI 3233
Double rounded jaw wire bending pliers. For wires up to 0,7 mm. (.028").



AKI 3234
Bird beak pliers for bending round, square or rectangular wire up to 0.7 mm. (.028"). With cutter.



AKI 3235
Double rounded jaw wire bending pliers. For wires up to 0,7 mm. (.028").



AKI 3236
USA Model
125 mm



AKI 3237
Waldron
125 mm



AKI 3238
How
140 mm



AKI 3239
How
145 mm



AKI 3240
Adams
125 mm



AKI 3241
Angle
125 mm



AKI 3242
young
130 mm



AKI 3243
Nance
130 mm



AKI 3244
Weingart
140 mm



AKI 3245
Johnson
130 mm



AKI 3246
Mc Kellops
155 mm



AKI 3247
Universal
150 mm

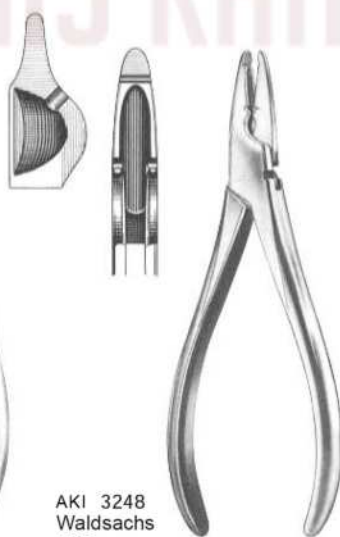

AKI 3248
Waldsachs
155 mm

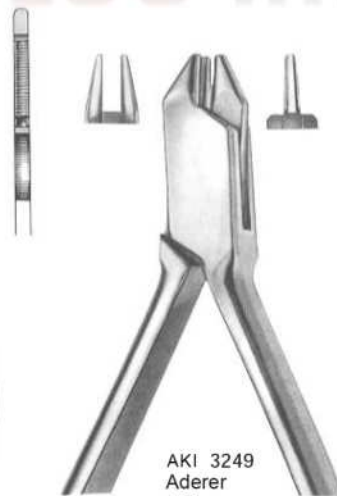

AKI 3249
Aderer
125 mm



AKI 3250
Nance
130 mm



AKI 3251
Langenbeck
140 mm



AKI 3252
Langenbeck
130 mm



AKI 3253
Langenbeck
130 mm



AKI 3254
Peeso
125 mm



AKI 3255
Goslee
125 mm

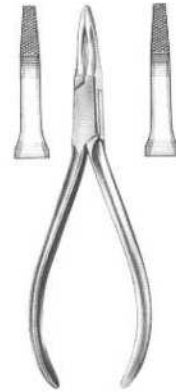

AKI 3256
Fischer
140 mm



3257
Andresen
130 mm



3258
Schwarz
130 mm



3259
MSY
130 mm

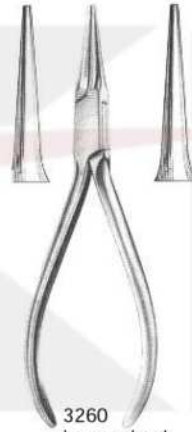

3260
Langenbeck
125 mm



AKI 3262



AKI 3263



AKI 3264



AKI 3265



AKI 3266



AKI 3267



AKI 3268



AKI 3269



AKI 3270



AKI 3271



AKI 3272

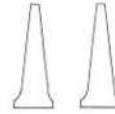

AKI 3273

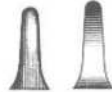

AKI 3274



AKI 3275



AKI 3276



AKI 3277



AKI 3278



AKI 3279



AKI 3280



AKI 3281



AKI 3282

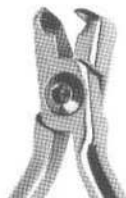

AKI 3283



AKI 3284



AKI 3285



AKI 3286

All Impression Trays Upper & Lower Type are available in S, M, L & XL Sizes



AKI 3300
"HYDRO-LOCK"
stainless steel
water-cooled
impression trays
with retention rim.



AKI 3301
"HYDRO-LOCK"
stainless steel
water-cooled impression
trays with retention rim.



AKI 3302
"NEW SUPER"
stainless steel
impression trays
with retention rim.



AKI 3303
"NEW SUPER" stainless
steel impression trays
with retention rim.



AKI 3304
"ANATOMIC" solid
regular stainless
steel impression
trays without
retention rim.



AKI 3305
"ANATOMIC" solid regular
stainless steel impression
trays without retention rim.

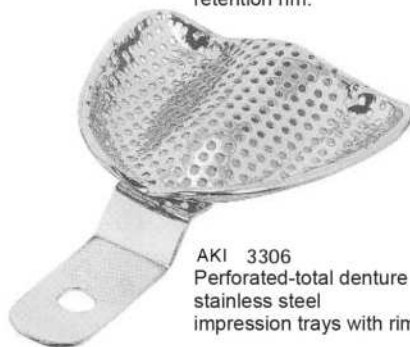

AKI 3306
Perforated-total denture
stainless steel
impression trays with rim.



AKI 3307
Perforated-total denture
stainless steel
impression trays with rim.

All Impression Trays Upper & Lower Type are available in S, M, L & XL Sizes



AKI 3308
"PERMA-LOCK" solid regular stainless steel impression trays with retention rim.



AKI 3309
"PERMA-LOCK" solid regular stainless steel impression trays with retention rim.



AKI 3310



AKI 3311



AKI 3312



AKI 3313



AKI 3314



AKI 3315



AKI 3317
Set of Eight



3318
Solid stainless steel anterior depressed impression trays with retention rim.



AKI 3319



AKI 3320



AKI 3321



AKI 3322



AKI 3323



AKI 3324



AKI 3325
Solid stainless steel anterior depressed impression trays with retention rim.

All Impression Trays Upper & Lower Type
are available in S, M, L & XL Sizes



AKI 3326
Fig. 0 per bambini - for children



AKI 3327
For narrow toothed upper jaws



AKI 3328
Fig. 0 per bambini - for children



AKI 3329
For partially toothed upper jaws



AKI 3330
For partially toothed lower jaws



AKI 3331
For edentulous upper jaws



AKI 3332
For edentulous lower jaws

All Impression Trays Upper & Lower Type are available in S, M, L & XL Sizes



AKI 3333
Solid total denture stainless steel impression tray with rim.



AKI 3334
Solid total denture stainless steel impression tray with rim.



AKI 3335
"PERMA-LOCK" perforated regular stainless steel impression trays with retention rim.



AKI 3336
"PERMA-LOCK" perforated regular stainless steel impression trays with retention rim.



AKI 3337
Perforated stainless steel anterior depressed impression trays with retention rim.



AKI 3338



AKI 3339



AKI 3340



AKI 3341



AKI 3342



AKI 3343



AKI 3344
Perforated stainless steel anterior depressed impression trays with retention rim.



AKI 3345
Perforated stainless steel impression trays without retention rim for complete denture.



AKI 3346
Perforated stainless steel impression trays without retention rim for complete denture.



AKI 3400



AKI 3401



AKI 3402



AKI 3403



AKI 3404



AKI 3405

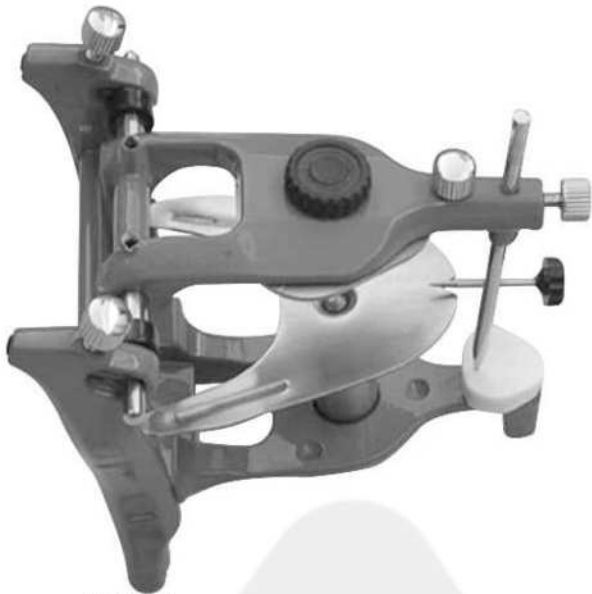

AKI 3406



AKI 3407

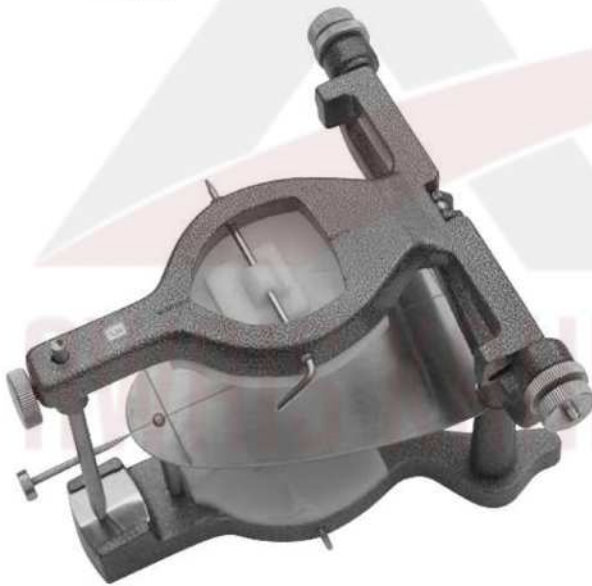

AKI 3408



AKI 3409



AKI 3500
ENDODONTIC BOX



AKI 3501
STERILIZING BOX
Available in dif. sizes
17x17x3 cm
20x10x4 cm
25x12x6 cm
30x14x6 cm



AKI 3502
ENDO TRAY BOX



AKI 3503
COTTON DISPENSER



AKI 3504
ALCOHOL LAMP

Sterilizing Drums



AKI 3505



AKI 3506



AKI 3507

Sterilizing Boxes



AKI 3508



AKI 3509



AKI 3510

Sterilizing Boxes



AKI 3511



AKI 3512



AKI 3513



AKI 3514

FORCEP AND THERMOMETER JARS



AKI 3515



AKI 3516

COTTON DISPENSER



AKI 3517
IRRIGATOR(Douch can)



AKI 3518
MEASURING JUG



AKI 3519
KIDNEY TRAY



AKI 3520
FORCEP JAR



AKI 3521
GALLIPOT WITH & WITHOUT LID



AKI 3522
SPITTEN MUG



AKI 3523
SPIRIT LAMP



AKI 3524
Perforated Tray



AKI 3525
Perforated Base



AKI 3526
Solid Base



AKI 3527
Instruments Tray



AKI 3528
Instruments Tray



AKI 3529
Instruments Tray
(Perforated)



AKI 3530
Instruments Tray Shallow
(Mayo)



AKI 3531
Scalers Tray



AKI 3532
Cathetar Tray



AKI -1779

Crown Scissors 4.5" – Straight



AKI -1780

Crown Scissors 4.5" – Curved



AKI -1781

Crown Scissors 4.5" - Straight, Serrated



AKI -1782

Crown Scissors 4.5" - Curved, Serrated



AKI -1783

Dean Scissors 7" - Angled, Serrated



AKI 1784

Goldman-Fox Scissors 5" - Curved, Serrated



AKI 1785

Kelly Scissors 6.25" – Angled



AKI-1786

Kelly Scissors 6.25" – Straight



AKI 1787

Kelly Scissors 6.25" – Curved



AKI 1788

Wagner Scissors 4.75" – Angled
Serrated



AKI 1789

Wagner Scissors 4.75" – Straight



AKI 1790

Wagner Scissors 4.75" - Curved,



AKI 1791

Quimby Gum Scissors 5" – Straight
S/S, Straight



AKI 1792

Quimby Gum Scissors 5" – Curved



AKI 1793

Operating Scissors 5.5" -



AKI 1794

Operating Scissors 5.5" - S/S, Curved
5.5" - B/B, Curved



AKI 1795

Operating Scissors 5.5" - S/B, Straight



AKI 1796

Operating Scissors



AKI 1797

Mayo Scissors 5.5" – Straight



AKI 1798

Mayo Scissors 5.5" – Curved



AKI 1799

Spencer Stitch Scissors 3.5"



AKI 1600

Shortbeak Stitch Scissors 3.5" – Curved
6.25"



AKI 1601

Littauer Stitch Scissors 4.5"



AKI 1602

Extra Long Stitch Scissors



CONTACT US

ADDRESS: Ugoki Road, Adalat Garah, Sialkot 51310 Pakistan.

WHATSAPP: +92 345 0283628

E-MAIL: info@awaiskahlooindustry.com

WEBSITE: www.awaiskahlooindustry.com